



SAFE



GREEN



ENERGY SAVING



SERVICE



E-mail: [info@rital.com.tr](mailto:info@rital.com.tr) whatsapp: +905303317401 +90 536 814 04 60 Address: Kayabaşı Mh. Akzambak

We reserve the right to alter some of specifications and descriptions given here in without prior notices



# CUBE

New Energy Home Lift  
with Battery Drive

Villa lift limited to single family



# Innovation & fashion of elevator industry

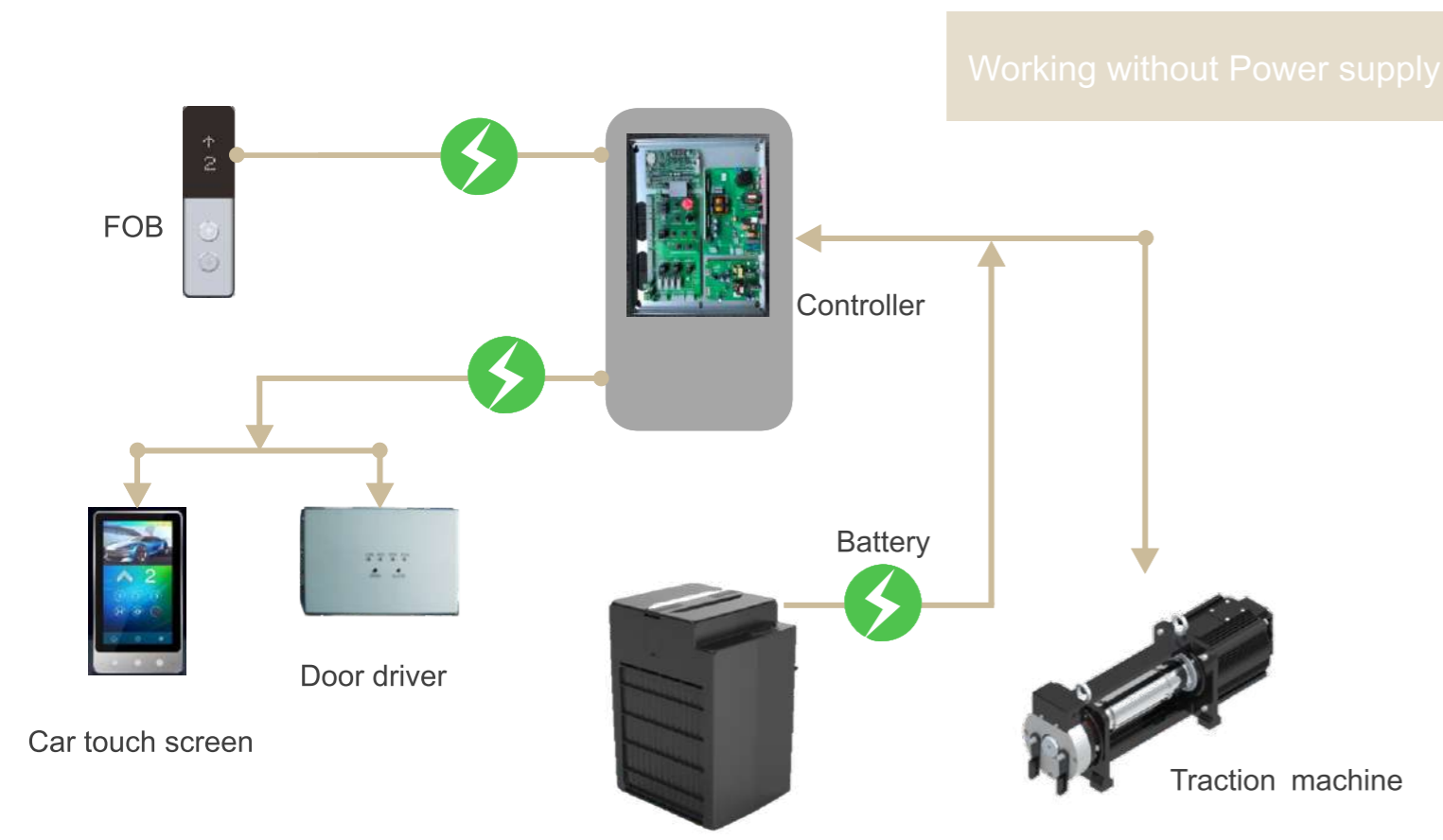
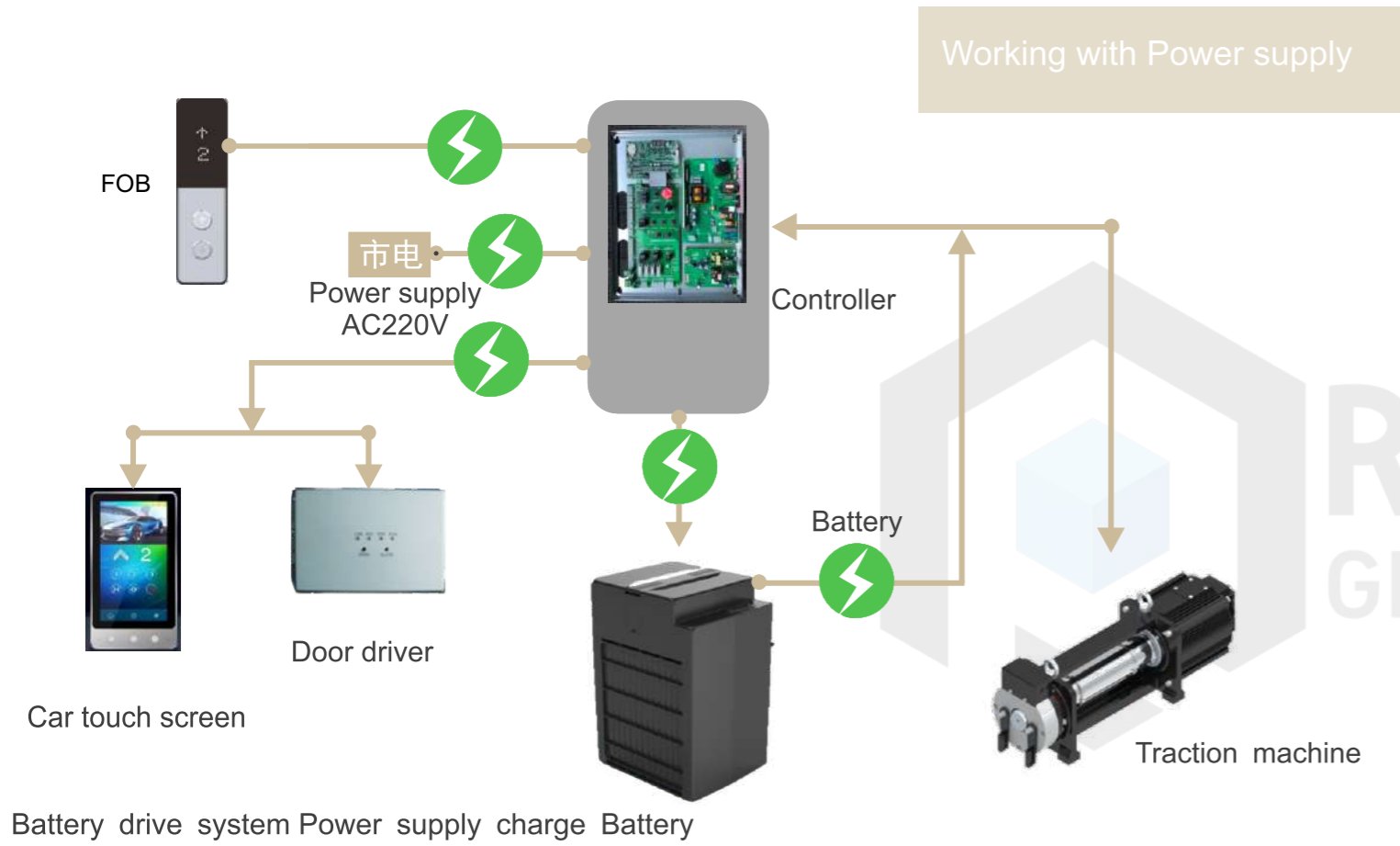

# Features of CUBE

More economical

Time-of-use Tariff of Power

Charge in Trough time, Consume in Peak time

In Time-of-use tariff of power May save cost by 40%

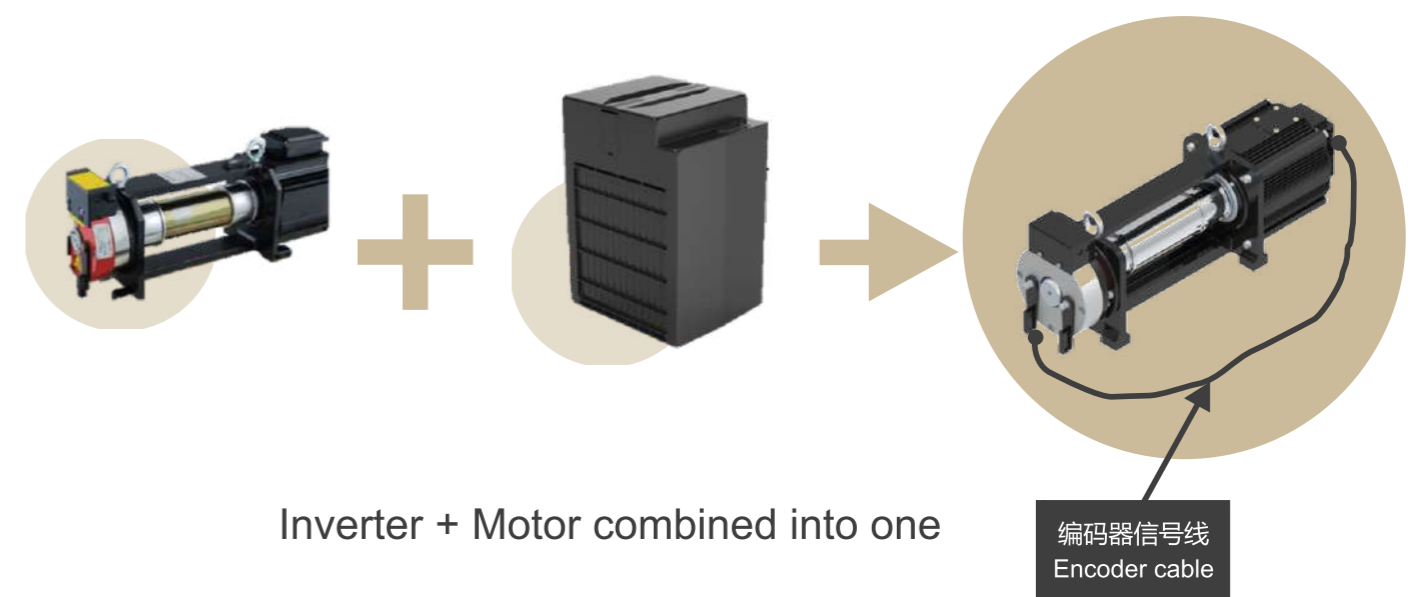
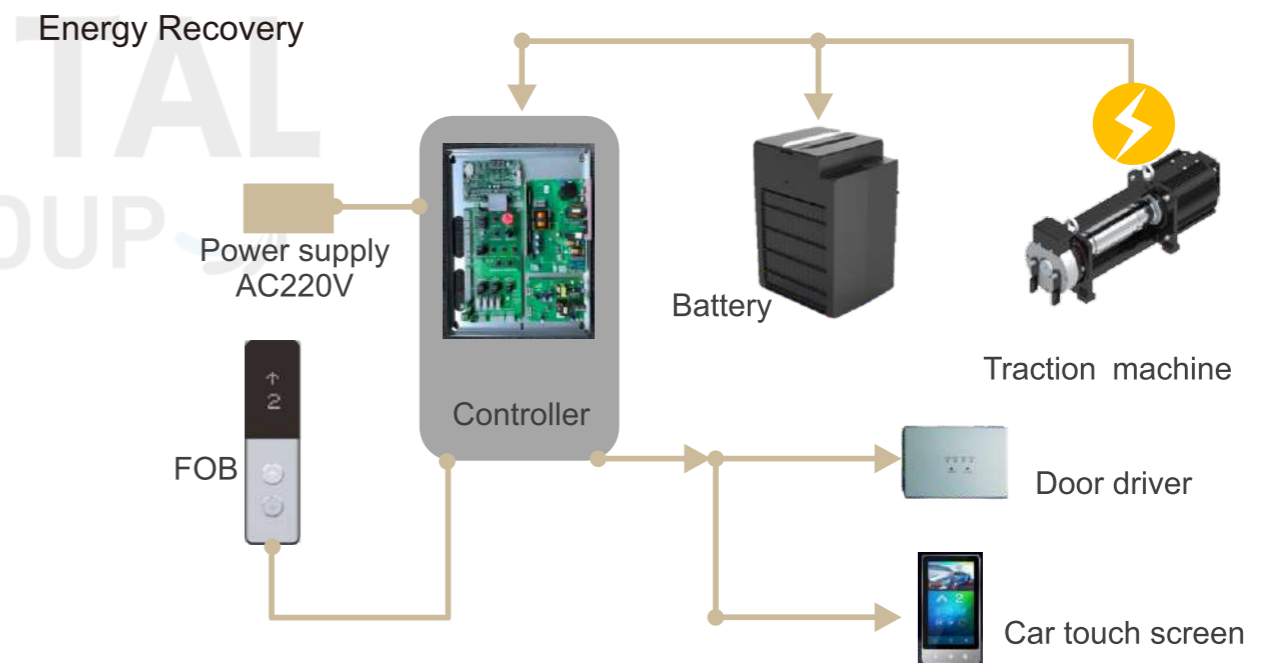

- Control Box placed in flexible position
- Short transmission of Encoder signal

# CUBE

Features of CUBE



## SMALL CONTROLLER

Intergrated design, deep integration

The volume is 17% of the current mainstream

325mm\*425mm\*50mm

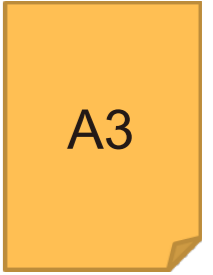

## BEAUTIFUL CONTROLLER

Various appearances, high profile



## QUIET CONTROLLER

No Contactor/Fans/Brake Resistance

With ARD



## STALBE & SAFE

Battery Health Monitor

Automatic Releveling when Low-Power

Automatic Rescue when Battery Failure

### BMS Battery Management System



Special shaft solutions

Center Opening 4 Panles Through Opening

Hairline classical car  
GJD-001A



Ceiling: Hairline stainless steel  
LED downlight  
Front wall: Hairline stainless steel  
Round wall: Hairline stainless steel  
Car door: PVC  
Control Box: 10.1 inch LCD display

Hairline stainless steel

Mirror stainless steel



Natural color



Natural color



Champagne gold color



Champagne gold color



Bronze color



Bronze color

Hairline stainless steel



Natural color



Titanium gold color

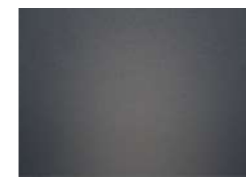

Dark -Ti color



Car door panel series

Hairline stainless steel

Mirror stainless steel

Brushed stainless steel

Etched stainless steel

Glass door series

Hairline stainless steel



Natural color hairline stainless steel



Champagne gold color hairline stainless steel



Bronze color hairline stainless steel

Mirror stainless steel

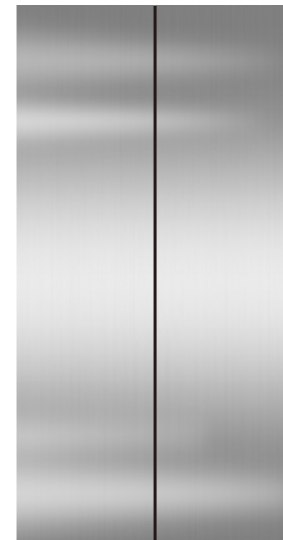

304 natural color mirror stainless steel

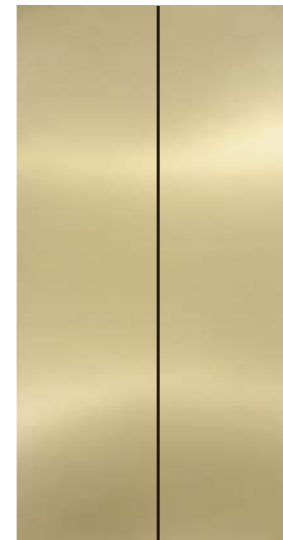

304 champagne gold color mirror stainless steel



304 bronze color mirror stainless steel



304 titanium gold color mirror stainless steel

## Brushed stainless steel

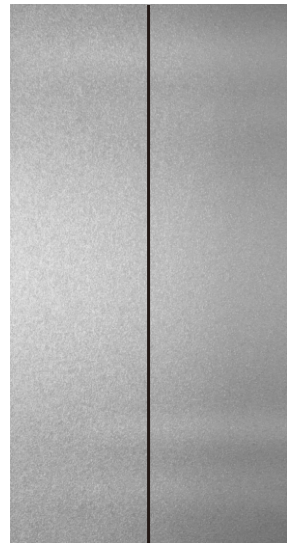

304 natural color  
brushed stainless steel



304 dark-Ti color  
brushed stainless steel

## 304 etched mirror stainless steel

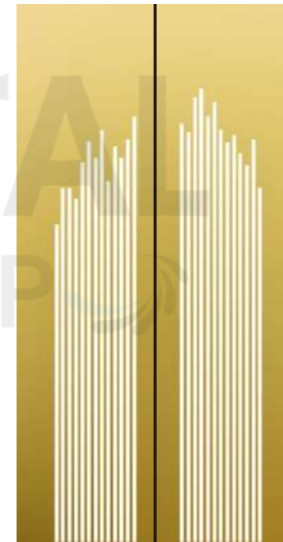

GK005



GK006



GK007

## 304 etched mirror stainless steel



GK001

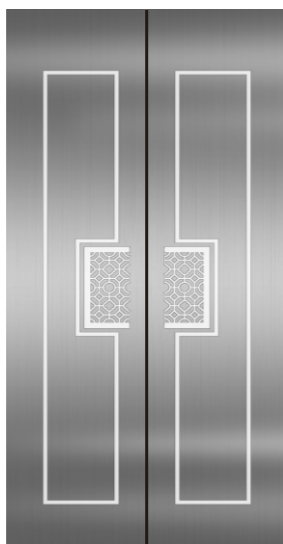

GK002

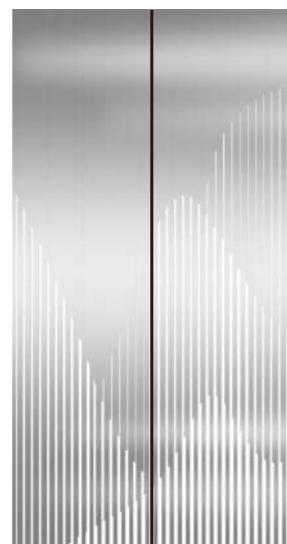

GK003



GK004



GK008

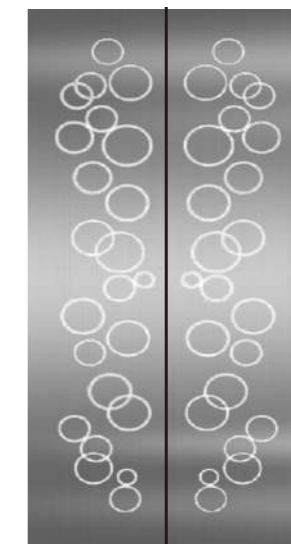

GK009



GK010





Glass door series (door frame 304 hairline titanium coating )



Glass door with dark-Ti color frame



Glass door with champagne gold color frame



Glass door with rose gold color frame



Glass door with 304 natural color frame



Glass door with titanium gold color frame





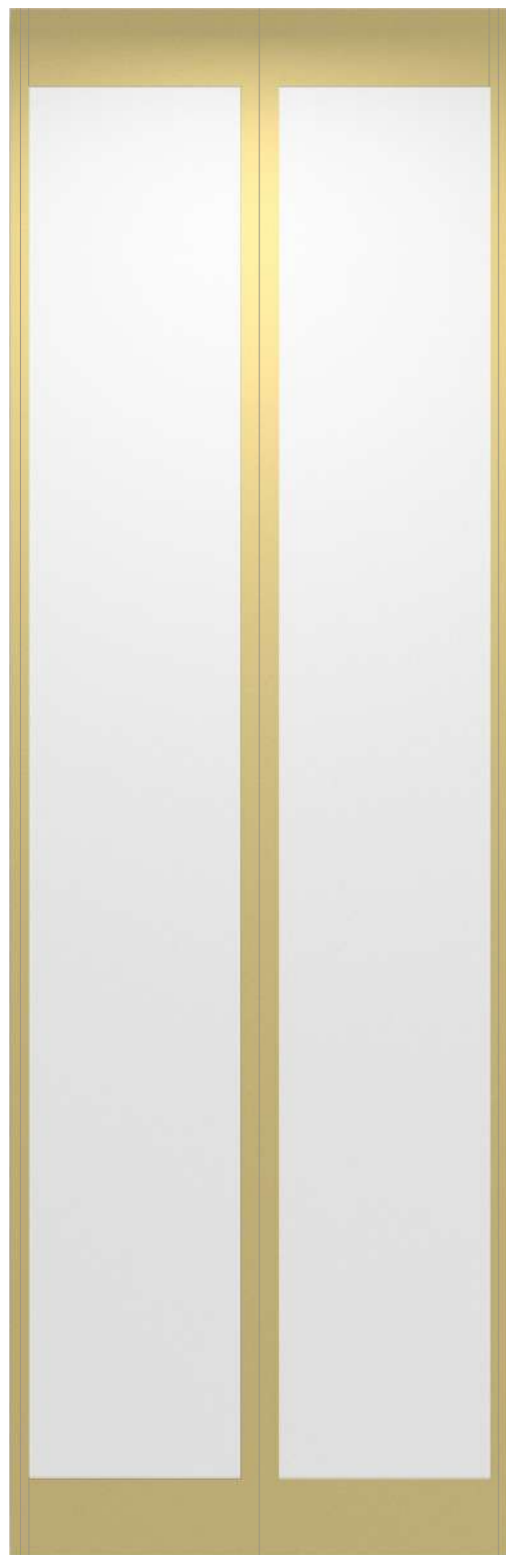

Glass door with bronze color frame

RITA GROUP

Glass door series (Aluminum alloy frame plating)

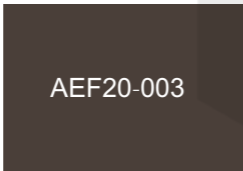
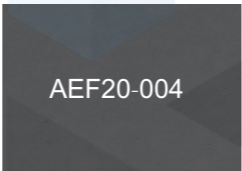

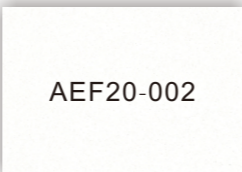
 AEF20-001 Black sand textured spraying	 AEF20-007 Light Champagne
 AEF20-003 Coffee sand textured spraying	 AEF20-004 Grey sand textured spraying
 AEF20-011 Gold color	 AEF20-002 White sand textured spraying

- 25mm narrow frame, more penetrating
- Unified color plating, better fits aluminum shaft
- Suit for center opening 40mm sill, side opening 70mm sill, more compact in size
- Cover door opening width 600mm~1200mm
- Choose aluminum alloy door needs to update drawing synchronously

RITAI GROUP





RITAL GROUP

Manual swing door series Automatic swing door series



Champagne gold color manual swing door series

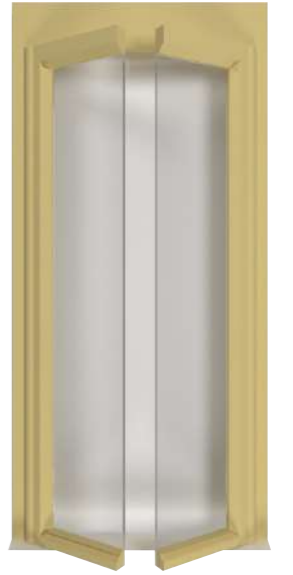

Titanium gold color automatic swing door series

More colors to choose from

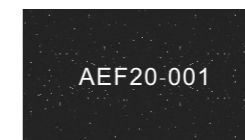

Black sand textured spraying



Light Champagne

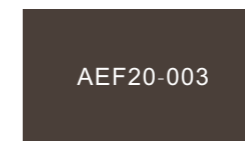

Coffee sand textured spraying

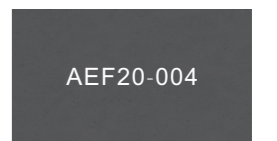

Grey sand textured spraying



Gold color



White sand textured spraying

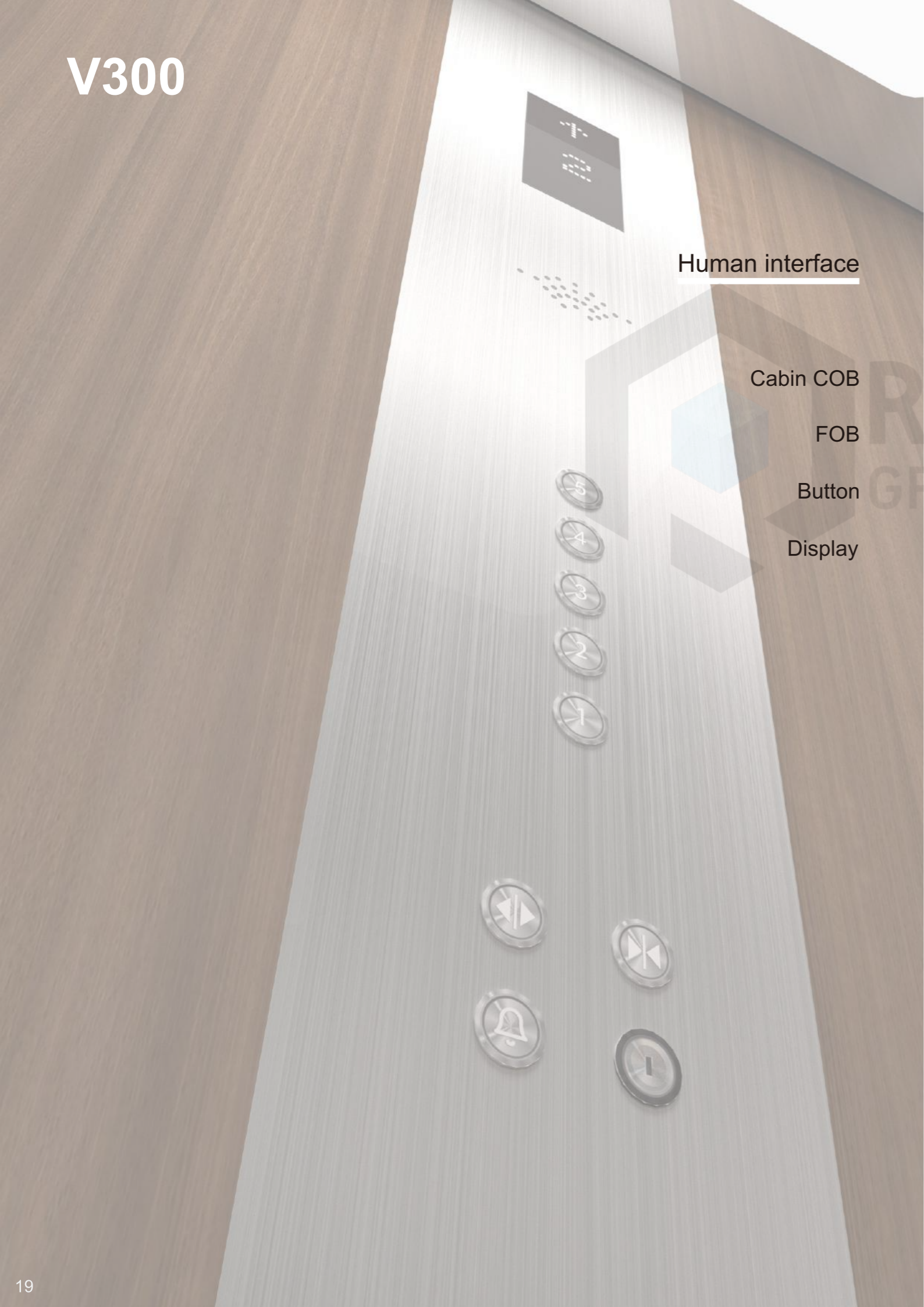

COB-325

Option COB-325

Full height COB(material and color same as cabin decoration. Common styles as follows)



Natural color mirror stainless steel

Dark-Ti color mirror stainless steel

Champagne gold color mirror stainless steel

Bronze color mirror stainless steel

Titanium gold color mirror stainless steel



Natural color hairline stainless steel

Champagne gold color hairline stainless steel

Bronze color hairline stainless steel

Dark-Ti color hairline stainless steel

Rose gold color hairline stainless steel

Titanium gold color hairline stainless steel

## Control box and Landing Fixture

Standard



SH-CMP-D101

10.1 inch LCD



5 inch Touch Landing Figure



SH-HCP-027  
Color screen Touch Landing Figure

Standard



SH-HDZ-017  
Dot Matrix Touch Landing Figure

Option



COB-325

Full height COB  
Standard



FOB340  
Standard

Option



PB254

Touch button



XMT-S1

Option



Etouch-101  
LTE-TDD/LTE-FDD  
Touch LCD  
(availability of call function may depend  
on local telecoms comp any)



EPAD-042  
White symbol with black background

V300

Car Ceiling

Option series

Standard series



(GT601)  
Sky Ceiling

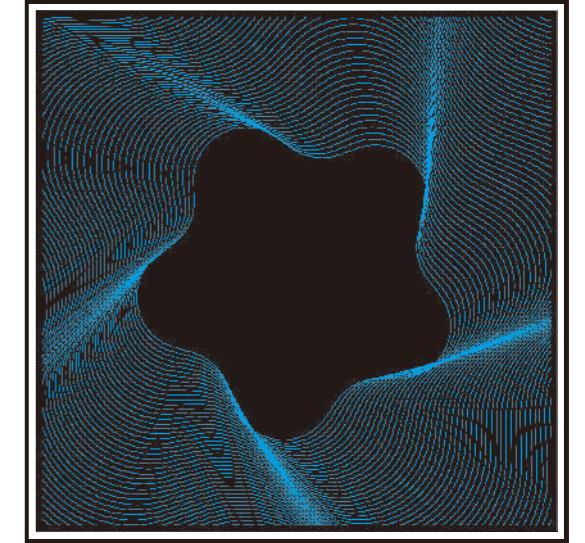

(GT602)  
Brilliant heart Ceiling

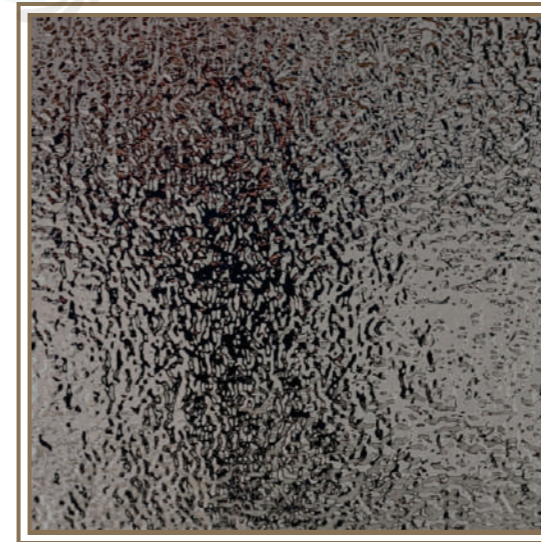

(GT603)  
Water ripples Ceiling



(GT604)  
Mirror Ceiling

RITAL  
GROUP

## Car Floor

PVC series

Marble-like series

## Standard PVC series



GF001

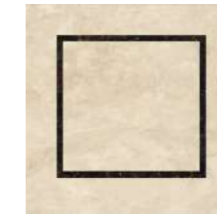

GF003



GF004



GF005



GF006



GF007

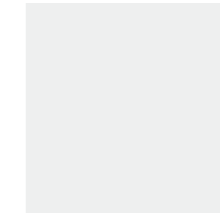

GF008



GF101

## Mable series



GF009

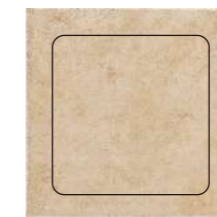

GF010

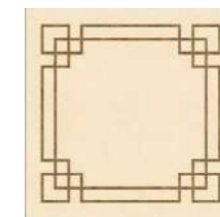

GF011



GF012



GF013



GF014



GF015



GF016

Parquet marble is made of artificial marble, natural marble, granite and other stone splicing, the specific stone depending on the effect of the parquet.

## (CUBE)

### Paint Surface

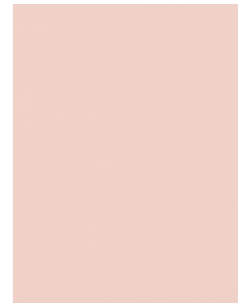
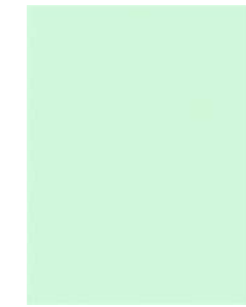
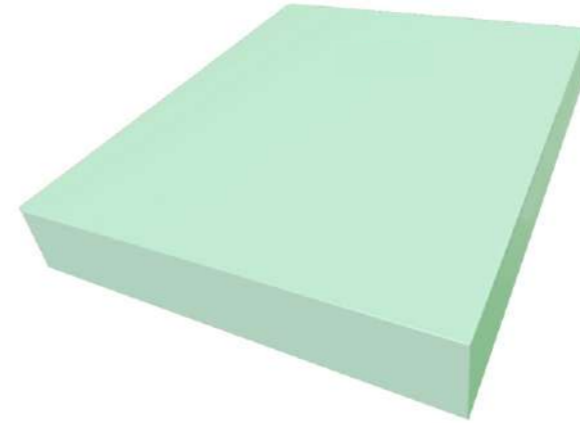

Light apple green Paint

Rose golden Paint

CUBE size around 325\*425\*50mm

### Artistic Paint Surface



GC001



GC002



GC003



GC004



GC005



GC006

Control cabinet

Paint series

Color paint series

### Product features

- Innovation

In line with the pulse of the new energy era, control system distributed layout

Completely hidden installation, more novel and beautiful

- Quiet

SIL3 level contactless control technology

Low voltage MOS tube replaces IPM to achieve noiseless driving

- Comfortable

High performance drive platform

Completely solve the problem of comfort, so that you can have a comfortable and beautiful elevator experience

- Safe

DC 48V power supply can achieve never power off without ARD or brake resistor.

Integration of a variety of security technologies, so that you can always enjoy the peace of mind

RITAL GROUP

# XCR-2000

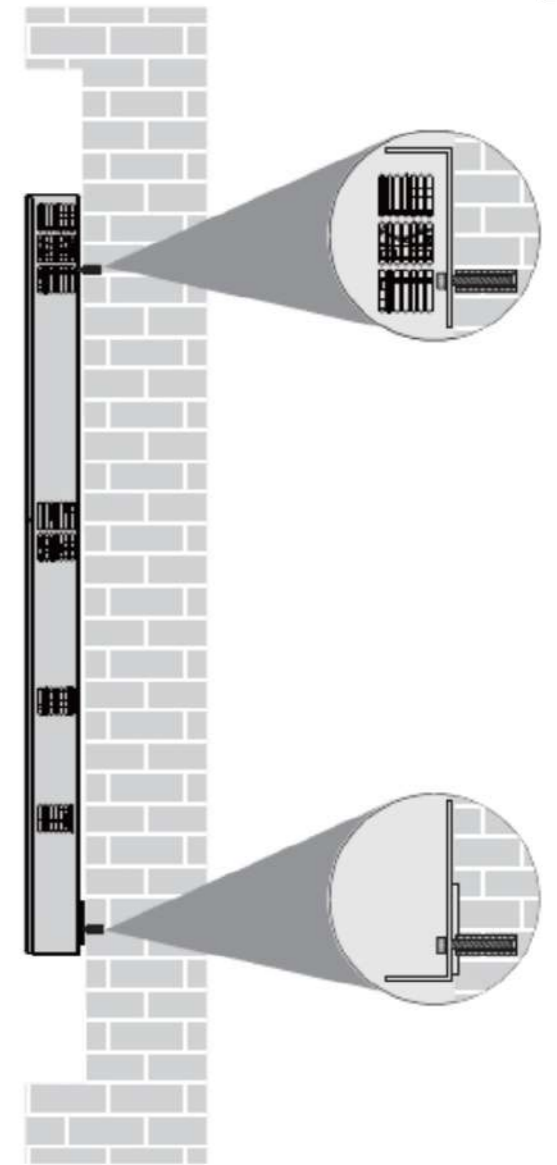
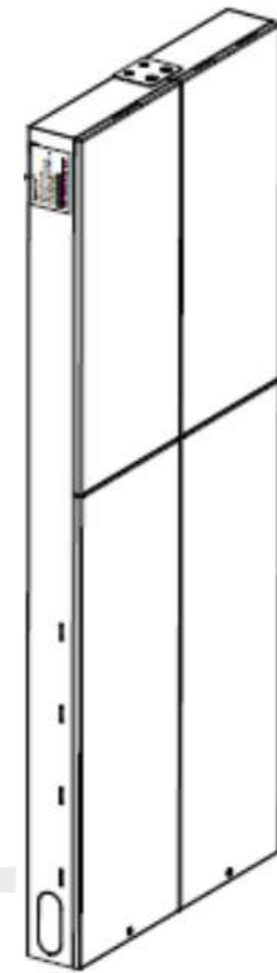

XCR2000 size around 320\*810\*58(mm)  
Can be installed separately

## Product introduction

The XCR2000 series is a general-purpose intelligent controller for home elevators, and the system adopts the driving and control technology that keeps pace with the times to build a safer and more comfortable general solution for home elevators and achieve a higher quality of smart home life.

Lean design Delicate and compact: ultra-thin design, can be installed concealedly, so that you have a more exquisite and beautiful elevator

Flexible installation: The twin shape can easily support a variety of installation methods inside and outside the hoistway, making full use of the building space

Safe and reliable to the highest standard: meet the relevant requirements of CE, better quality

Multiple protection: Integrate intelligent rescue mode and manual rescue mode, and operate reliably

Comfortable experience Smooth operation: Optimized acceleration and deceleration curves provide a more comfortable riding experience

Silent control: The operating volume is less than 40 decibels, enjoy a quieter and beautiful space

Overvoltage protection	When the power supply voltage is greater than the maximum allowed value, the system automatically protects the power supply.
Motor overload protection	When motor overload is detected, the system automatically protects it.
Encoder fault protection	Only one high-speed encoder is used for closed-loop vector control in the whole system. If the encoder fails, the system will stop automatically to eliminate the top and bottom punching failures caused by failure of the encoder.
Shaft self-learning failure diagnosis	Without correct hoistway data, the elevator will not operate normally, so hoistway self-learning failure diagnosis is set when the hoistway self-learning is not completed correctly.
Door switch fault protection	The system detects that the elevator cannot be effectively closed after the door is opened and closed more than the set number of times, and the system stops opening and closing the door and displays the fault.
Door lock disconnection protection during operation	The system automatically protects when door lock disconnection is detected during elevator operation.
Limit switch protection	Under the automatic operation mode, the elevator can identify the adhesion and loss of leveling signal.
Overspeed protection	Ensure that the speed of the car during operation is within the safety control range to ensure the safety of passengers.
Leveling switch fault protection	Under the automatic operation mode, the elevator can identify the adhesion and loss of leveling signal.
Abnormal detection of output contactor	Before the band type brake is opened, judge whether the output contactor is abnormal by detecting the output current.
Short circuit to ground detection	When the system is powered on for the first time, it can detect the output U, V and W to determine whether there is a short circuit to ground.

## Emergency Function

Emergency electric operation of machine room	The control cabinet is equipped with an emergency electric running device in the machine room, which can be operated by professionals in case of emergency
One touch dialing (wired)	In case of emergency, passengers can press the alarm button on the control box in the car to help out.
Emergency lighting in car	Emergency lighting device is set in the car.
Power failure rescue function	When the elevator is powered off, it will automatically enter the power-off rescue state. The elevator will automatically run to the nearest floor and open the car door to let passengers out
Electric brake release function	In case of emergency, professionals can use the electric brake release function to move the car to the leveling position, open the car door to let passengers out,

## Nonstandard Function

Nonstandard Function	One touch dialing (wireless): In case of emergency, passengers can press the alarm button on the control box in the car to help out.
Ladder locking function	Under the automatic operation state, after the lock switch acts, all call registration will be eliminated. Then return to the elevator lock base station and open the door automatically. After that, the elevator stops running, and the lighting and fan in the car are turned off. When the lock switch is reset, the elevator returns to the normal service state.
Arrival gong in car	Different sounds will be made when the car goes up to floor and goes down to floor.
True color display in car	The display of the control box in the car is replaced with true color display (picture machine)
Video display in car	The display of the control box in the car is replaced with true color display (video machine)
Touch screen	The control box in the car is changed into a touch screen.
External call touch	The outbound call is changed to a touch button, which is limited to the aluminum alloy frame.
Voice station announcement in car	The arrival will be announced by voice.
Gesture call	The elevator can be called to run by gesture.
Face recognition call	The elevator will register the call command only if the face recognition is successful.
Parallel lighting	Add parallel lamp

## Basic function

Operation Function	
Maintenance operation	When the elevator enters the maintenance state, the system cancels the automatic operation and automatic door operation. Press the up (down) button to make the elevator run up (down) at the maintenance speed point. Release the button to stop the elevator immediately.
Direct travel leveling	The running curves are automatically calculated and generated based on the distance by the control system, enabling the elevator to directly stop at the leveling position without creeping.
Floor position auto-correction	Every time when elevator pass leveling plate, floor position pulse will be corrected to theory value got from shaft learning.
	For permanent magnet synchronous motor, the control system can complete the angle recognition of rotary encoder.
Shaft learning	Shaft learning is required before first time automatic running. During shaft learning, the elevator runs from the bottom floor to the top floor at the inspection speed, and all position signals in the shaft will be automatically recorded.
Automatic correction of lift car position	Each time the elevator runs to the end station position, the system automatically checks and corrects the position information of the car according to the first level forced deceleration switch, and at the same time, assists the specially made forced deceleration to completely eliminate the top and bottom punching faults.
Error instruction cancellation	Passengers can press the button twice continuously in the COP to cancel the last error command.
Reverse automatic cancellation	When the elevator runs to the terminal floor or the running direction changes, all the previously registered reverse commands will be automatically cancelled.
The hall on this floor opens outside	In the absence of other instructions or external calls, if the car stops at a landing, press the call button outside the landing, the car door will open automatically.
Close button closes the door in advance	In the automatic operation mode, when the elevator is in the door opening hold mode, the door can be closed in advance through the door closing button to improve efficiency.
Door open holding time setting	The system automatically determines different door open time for door open for call, command, protection, or delay according to the set door open holding time.
Full collective selective	In automatic running or attendant state, this function enables the elevator to respond both car calls and hall calls. Passengers at any service floor can call the elevator by pressing the up call button and down call button.

Leveling fine adjustment

The leveling accuracy can be fine adjusted by adjusting the parameters.

Fault History

The system has the function of fault recording, including the time and floor of the fault.

Automatic generation of optimum curve

The optimum speed curve is automatically calculated and generated by the system based on the distance, complying with the human - machine principle, without being limited by the number of curves or short floor.

Forced deceleration monitoring function

Under the automatic operation mode, the system monitors and corrects the position of the elevator car according to the position of the forced deceleration switch and the action of the switch.

## Safety Function

Terminal protection

The switches are provided to prevent the elevator from traveling beyond a terminal landing.

Open the door repeatedly

After the elevator keeps closing for a certain time, if the door lock is not closed, the elevator will automatically open the door and then close the door repeatedly.

Stop at another station

If the elevator keeps opening the door for more than a certain period of time and the door opening limit has not yet been activated, the elevator will close the door and automatically go to the next landing after the door is closed.

Car overload protection

If car is loaded over rated load, lift will be hold and stopped with door open at the floor, and the alarm buzzer and overload sign will be activated.

Light curtain protection

In the process of closing the door, when there is something blocking the door, the light curtain protection acts, and the elevator turns to open the door. However, light curtain protection does not work in fire fighting operations.

No door opening protection outside the door area

The system is in a non door area state, and automatic door opening is prohibited.

Reverse operation protection

The system identifies the direction of the feedback signal of the rotary encoder, judges the actual running direction of the motor during operation, and gives an alarm when it runs in reverse direction.

Anti slip protection

In the non maintenance state, if the elevator runs continuously for the specified time (45 seconds at most) and no leveling switch acts, the system will detect the wire rope slipping fault and stop all operations.

Contact protect of contactor

When the elevator is running or stopped, the system will automatically protect when it detects that the closing state of the contactor is abnormal.

Motor overcurrent protection

When the motor current is detected to be greater than the maximum allowed value, the system automatically protects.

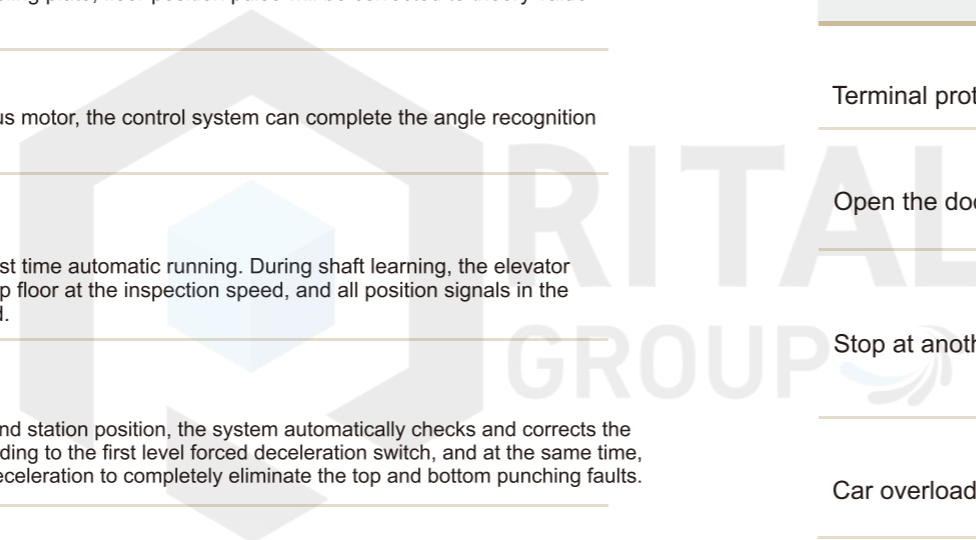

# V300-BR

## V300-BR Cantilever Type, with Traction Rope

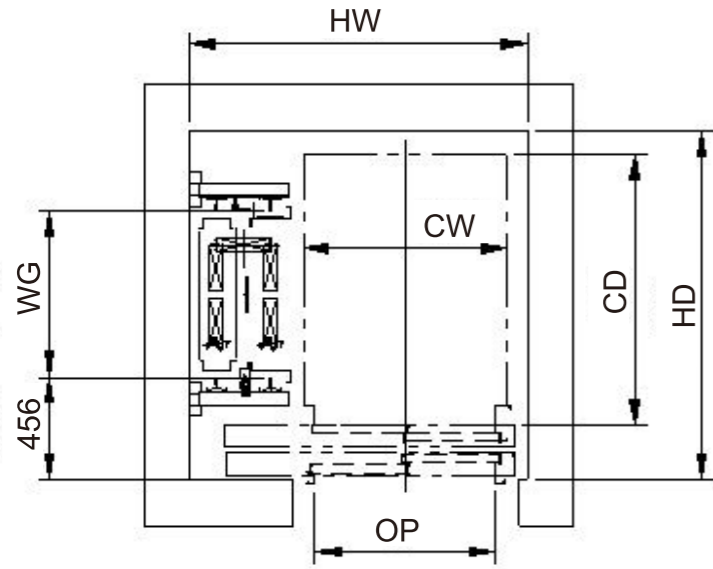

Note:  
pit depth 400  
When Car height 2220,  
overhead is 3000

HW \ HD	1350	1400	1450	1500	1550	1600
1350	轿厢Car:750*1000 TL:700*2000	轿厢Car:800*1000 TL:700*2000	轿厢Car:850*1000 TL:700*2000	轿厢Car:900*1000 TL:800*2000	轿厢Car:950*1000 TL:800*2000	轿厢Car:1000*1000 TL:800*2000
1400	轿厢Car:750*1050 TL:700*2000	轿厢Car:800*1050 TL:700*2000	轿厢Car:850*1050 TL:700*2000	轿厢Car:900*1050 TL:800*2000	轿厢Car:950*1050 TL:800*2000	轿厢Car:1000*1050 TL:800*2000
1450	轿厢Car:750*1100 TL:700*2000	轿厢Car:800*1100 TL:700*2000	轿厢Car:850*1100 TL:700*2000	轿厢Car:900*1100 TL:800*2000	轿厢Car:950*1100 TL:800*2000	轿厢Car:1000*1100 TL:800*2000
1500	轿厢Car:750*1150 TL:700*2000	轿厢Car:800*1150 TL:700*2000	轿厢Car:850*1150 TL:700*2000	轿厢Car:900*1150 TL:800*2000	轿厢Car:950*1150 TL:800*2000	轿厢Car:1000*1150 TL:800*2000
1550	轿厢Car:750*1200 TL:700*2000	轿厢Car:800*1200 TL:700*2000	轿厢Car:850*1200 TL:700*2000	轿厢Car:900*1200 TL:800*2000	轿厢Car:950*1200 TL:800*2000	轿厢Car:1000*1200 TL:800*2000
1600	轿厢Car:750*1250 TL:700*2000	轿厢Car:800*1250 TL:700*2000	轿厢Car:850*1250 TL:700*2000	轿厢Car:900*1250 TL:800*2000	轿厢Car:950*1250 TL:800*2000	轿厢Car:1000*1250 TL:800*2000

Note  
CO stands for two panels center opening, TL stands for two panels side openings, HW stands for hoistway width, HD stands for hoistway depth, and lift car size is wide × deep

V300

Platform ladder hairline classical car  
GJD-001A

- Ceiling: Hairline stainless steel
- LED downlight
- Front wall: Hairline stainless steel
- Round wall: Hairline stainless steel
- Car floor: PVC
- Control Box: 10.1 inch LCD display
- Car door: Without
- Light curtain: With



## V300-PT (≤320kg) V300-PT Side Counterweight

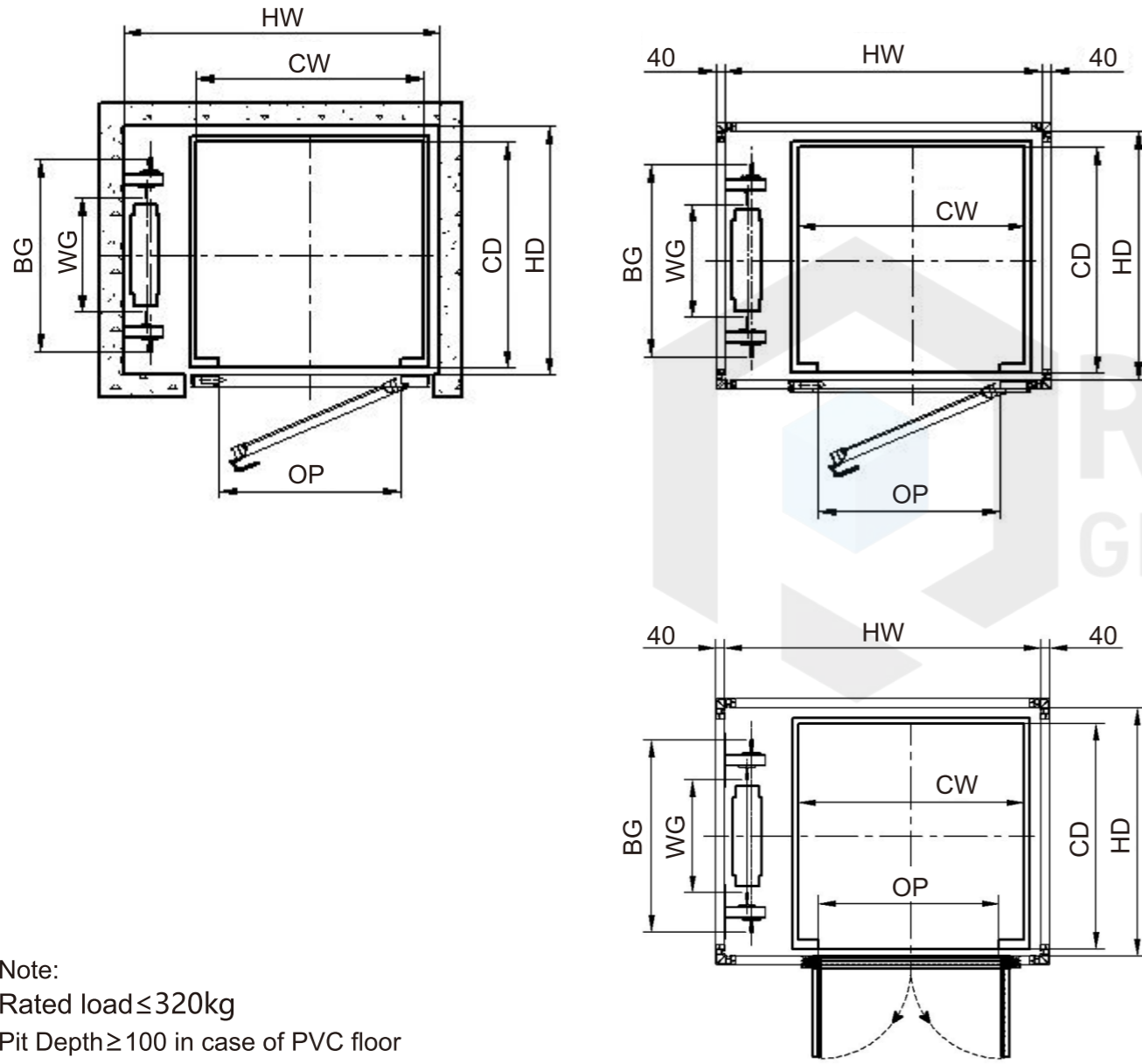

Note:  
 Rated load ≤ 320kg  
 Pit Depth ≥ 100 in case of PVC floor  
 Overhead ≥ 2500 in case of Car height 2220  
 The door opening type depends on the project specific and client's choice

### V300-PT Side Counterweight

HW HD	1050	1100	1150	1200	1250	1300	1350	1400
850	Car: 650*750 HA: 600*2000	Car: 700*750 HA: 650*2000	Car: 750*750 HA: 700*2000	Car: 800*750 HA: 750*2000	Car: 850*750 HA: 800*2000	Car: 900*750 HA: 800*2000	Car: 950*750 HA: 800*2000	Car: 1000*750 HA: 800*2000
900	Car: 650*800 HA: 600*2000	Car: 700*800 HA: 650*2000	Car: 750*800 HA: 700*2000	Car: 800*800 HA: 750*2000	Car: 850*800 HA: 800*2000	Car: 900*800 HA: 800*2000	Car: 950*800 HA: 800*2000	Car: 1000*800 HA: 800*2000
950	Car: 650*850 HA: 600*2000	Car: 700*850 HA: 650*2000	Car: 750*850 HA: 700*2000	Car: 800*850 HA: 750*2000	Car: 850*850 HA: 800*2000	Car: 900*850 HA: 800*2000	Car: 950*850 HA: 800*2000	Car: 1000*850 HA: 800*2000
1000	Car: 650*900 HA: 600*2000	Car: 700*900 HA: 650*2000	Car: 750*900 HA: 700*2000	Car: 800*900 HA: 750*2000	Car: 850*900 HA: 800*2000	Car: 900*900 HA: 800*2000	Car: 950*900 HA: 800*2000	Car: 1000*900 HA: 800*2000
1050	Car: 650*950 HA: 600*2000	Car: 700*950 HA: 650*2000	Car: 750*950 HA: 700*2000	Car: 800*950 HA: 750*2000	Car: 850*950 HA: 800*2000	Car: 900*950 HA: 800*2000	Car: 950*950 HA: 800*2000	Car: 1000*950 HA: 800*2000
1100	Car: 650*1000 HA: 600*2000	Car: 700*1000 HA: 650*2000	Car: 750*1000 HA: 700*2000	Car: 800*1000 HA: 750*2000	Car: 850*1000 HA: 800*2000	Car: 900*1000 HA: 800*2000	Car: 950*1000 HA: 800*2000	Car: 1000*1000 HA: 800*2000
1150	Car: 650*1050 HA: 600*2000	Car: 700*1050 HA: 650*2000	Car: 750*1050 HA: 700*2000	Car: 800*1050 HA: 750*2000	Car: 850*1050 HA: 800*2000	Car: 900*1050 HA: 800*2000	Car: 950*1050 HA: 800*2000	Car: 1000*1050 HA: 800*2000

Note:  
 Car: 650\*750, means Car Width 650mm and Car Depth 750mm;  
 HA: 600\*2000, means Manual Swing Door or Automatic Swing Door, Door opening width 600mm,  
 Door opening height 2000mm.  
 The Door sizes in above table are recommended, The door size may be changed when shaft changes.

\*

(≤320kg)

## V300-PT Rear Counterweight

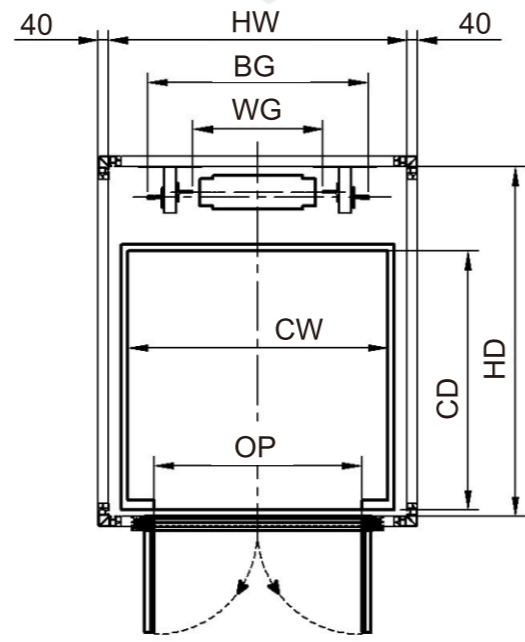
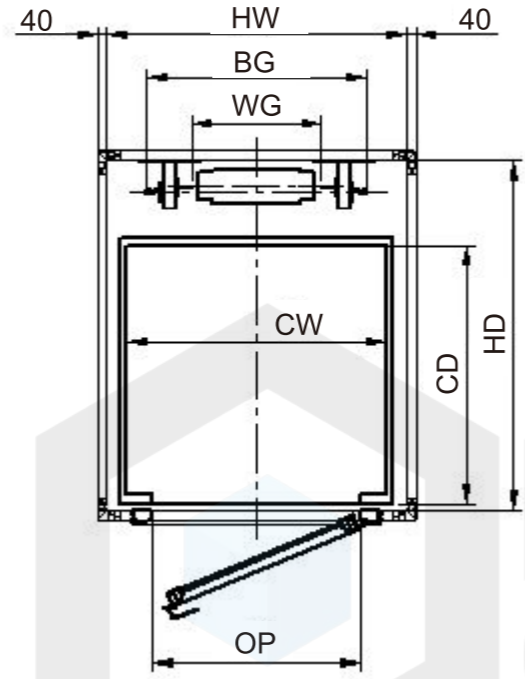
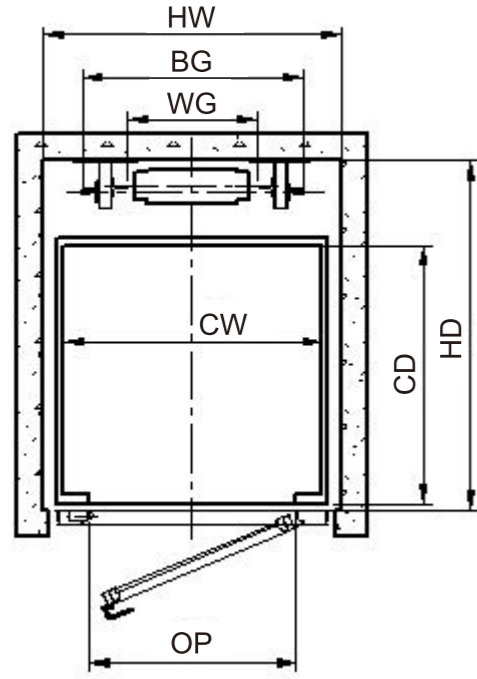

Note:  
 Rated load ≤ 320kg  
 Pit Depth ≥ 100 in case of PVC floor  
 Overhead ≥ 2500 in case of Car height 2220  
 The door opening type depends on the project specific and client's choice

## V300-PT Rear Counterweight

## V300-PT

HW	HD	900	950	1000	1050	1100	1150	1200
1000		Car: 750*650 HA: 650*2000	Car: 800*650 HA: 700*2000	Car: 850*650 HA: 750*2000	Car: 900*650 HA: 800*2000	Car: 950*650 HA: 800*2000	Car: 1000*650 HA: 800*2000	Car: 1050*650 HA: 800*2000
1050		Car: 750*700 HA: 650*2000	Car: 800*700 HA: 700*2000	Car: 850*700 HA: 750*2000	Car: 900*700 HA: 800*2000	Car: 950*700 HA: 800*2000	Car: 1000*700 HA: 800*2000	Car: 1050*700 HA: 800*2000
1100		Car: 750*750 HA: 650*2000	Car: 800*750 HA: 700*2000	Car: 850*750 HA: 750*2000	Car: 900*750 HA: 800*2000	Car: 950*750 HA: 800*2000	Car: 1000*750 HA: 800*2000	Car: 1050*750 HA: 800*2000
1150		Car: 750*800 HA: 650*2000	Car: 800*800 HA: 700*2000	Car: 850*800 HA: 750*2000	Car: 900*800 HA: 800*2000	Car: 950*800 HA: 800*2000	Car: 1000*800 HA: 800*2000	Car: 1050*800 HA: 800*2000
1200		Car: 750*850 HA: 650*2000	Car: 800*850 HA: 700*2000	Car: 850*850 HA: 750*2000	Car: 900*850 HA: 800*2000	Car: 950*850 HA: 800*2000	Car: 1000*850 HA: 800*2000	Car: 1050*850 HA: 800*2000
1250		Car: 750*900 HA: 650*2000	Car: 800*900 HA: 700*2000	Car: 850*900 HA: 750*2000	Car: 900*900 HA: 800*2000	Car: 950*900 HA: 800*2000	Car: 1000*900 HA: 800*2000	Car: 1050*900 HA: 800*2000
1300		Car: 750*950 HA: 650*2000	Car: 800*950 HA: 700*2000	Car: 850*950 HA: 750*2000	Car: 900*950 HA: 800*2000	Car: 950*950 HA: 800*2000	Car: 1000*950 HA: 800*2000	Car: 1050*950 HA: 800*2000
1350		Car: 750*1000 HA: 650*2000	Car: 800*1000 HA: 700*2000	Car: 850*1000 HA: 750*2000	Car: 900*1000 HA: 800*2000	Car: 950*1000 HA: 800*2000	Car: 1000*1000 HA: 800*2000	Car: 1050*1000 HA: 800*2000

Note:  
 Car: 650\*750, means Car Width 650mm and Car Depth 750mm;  
 HA: 600\*2000, means Manual Swing Door or Automatic Swing Door, Door opening width 600mm,  
 Door opening height 2000mm.  
 The Door sizes in above table are recommended, The door size may be changed when shaft changes.



## V300-PT Rear Counterweight (≤320kg)

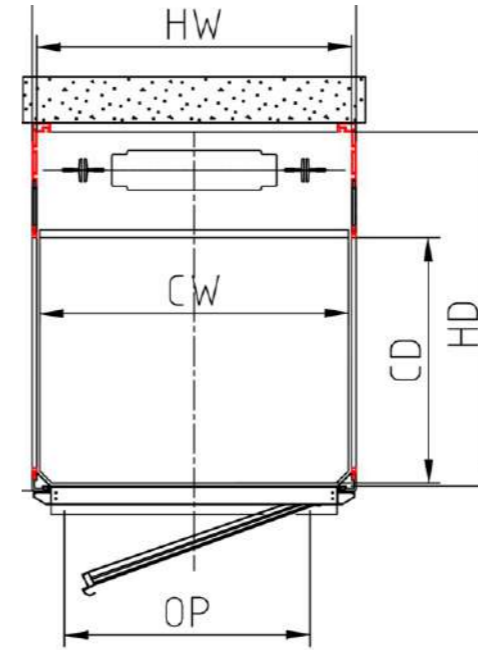

Note:  
 Rated load ≤ 320kg  
 Pit Depth ≥ 80 in case of PVC floor  
 Overhead ≥ 2500  
 The door opening type depends on the project specific and client's choice

Outer width of the shaft	855	905	955	1005	1055
Outer depth of the shaft					
1000	Platform:805*600 HA:600*2000	Platform:855*600 HA:650*2000	Platform:905*600 HA:700*2000	Platform:955*600 HA:750*2000	平台Platform:1005*600 HA:800*2000
1050	Platform:805*650 HA:600*2000	Platform:855*650 HA:650*2000	Platform:905*650 HA:700*2000	Platform:955*650 HA:750*2000	平台Platform:1005*650 HA:800*2000
1100	Platform:805*700 HA:600*2000	Platform:855*700 HA:650*2000	Platform:905*700 HA:700*2000	Platform:955*700 HA:750*2000	平台Platform:1005*700 HA:800*2000
1150	Platform:805*750 HA:600*2000	Platform:855*750 HA:650*2000	Platform:905*750 HA:700*2000	Platform:955*750 HA:750*2000	平台Platform:1005*750 HA:800*2000
1200	Platform:805*800 HA:600*2000	Platform:855*800 HA:650*2000	Platform:905*800 HA:700*2000	Platform:955*800 HA:750*2000	平台Platform:1005*800 HA:800*2000
1250	Platform:805*850 HA:600*2000	Platform:855*850 HA:650*2000	Platform:905*850 HA:700*2000	Platform:955*850 HA:750*2000	平台Platform:1005*850 HA:800*2000
1300	Platform:805*900 HA:600*2000	Platform:855*900 HA:650*2000	Platform:905*900 HA:700*2000	Platform:955*900 HA:750*2000	平台Platform:1005*900 HA:800*2000
1350	Platform:805*950 HA:600*2000	Platform:855*950 HA:650*2000	Platform:905*950 HA:700*2000	Platform:955*950 HA:750*2000	平台Platform:1005*950 HA:800*2000
1400	Platform:805*1000 HA:600*2000	Platform:855*1000 HA:650*2000	Platform:905*1000 HA:700*2000	Platform:955*1000 HA:750*2000	平台Platform:1005*1000 HA:800*2000

instruction  
 Outer width of shaft: The outer width of the shaft frame;  
 Outer depth of the shaft: the outer depth of the shaft frame;  
 The customer needs to prepare installation space:  
 outer shaft width+30mm, outer shaft depth+20mm  
 Platform: 850\*600 means platform width is 850mm and platform depth is 600mm  
 Platform size W= outer shaft width-50mm, D= Well outer depth-400mm;  
 HA:600\*2000 means door opening mode is swing door or manual door,  
 door width 600mm, door height 2000mm;  
 Swing door: OP= outer shaft width-300mm  
 Hand door: OP= outer shaft width-255mm  
 The aluminum shafts shall be fixed on the steel structure or the structure of concrete with ring beam.  
 The structure shall be at back side of shaft.  
 Rated load ≤ 320kg, opening doors mode chosen by specific projects and customer needs

# V300



Elevana

## V300-PT Plus Rear Counterweight (≤320kg)

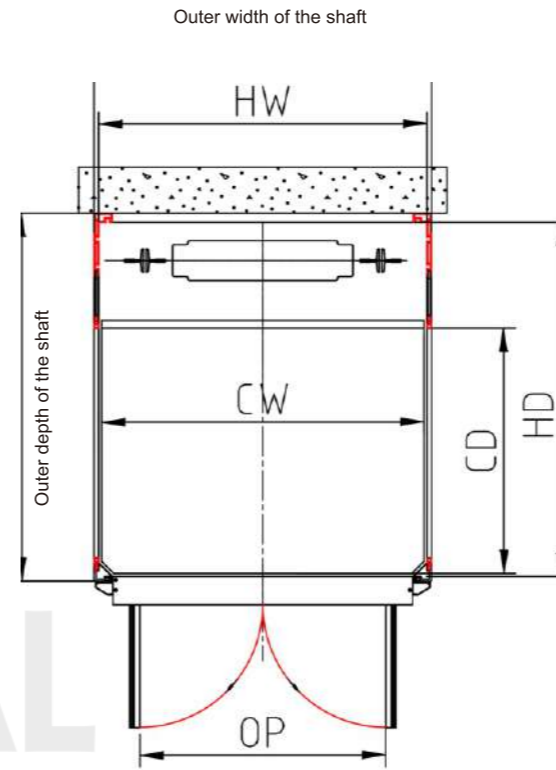

Note:  
 Rated load ≤ 320kg  
 Pit Depth ≥ 80 in case of PVC floor  
 Overhead ≥ 2500  
 The door opening type depends on the project specific and client's choice

Outer width of the shaft 井道外宽 Outer depth of the shaft	900	950	1000	1050	1100
1000	Platform:850*600 HA:600*2000	Platform:900*600 HA:650*2000	Platform:950*600 HA:700*2000	Platform:1000*600 HA:750*2000	Platform:1050*600 HA:800*2000
1050	Platform:850*650 HA:600*2000	Platform:900*650 HA:650*2000	Platform:950*650 HA:700*2000	Platform:1000*650 HA:750*2000	Platform:1050*650 HA:800*2000
1100	Platform:850*700 HA:600*2000	Platform:900*700 HA:650*2000	Platform:950*700 HA:700*2000	Platform:1000*700 HA:750*2000	Platform:1050*700 HA:800*2000
1150	Platform:850*750 HA:600*2000	Platform:900*750 HA:650*2000	Platform:950*750 HA:700*2000	Platform:1000*750 HA:750*2000	Platform:1050*750 HA:800*2000
1200	Platform:850*800 HA:600*2000	Platform:900*800 HA:650*2000	Platform:950*800 HA:700*2000	Platform:1000*800 HA:750*2000	Platform:1050*800 HA:800*2000
1250	Platform:850*850 HA:600*2000	Platform:900*850 HA:650*2000	Platform:950*850 HA:700*2000	Platform:1000*850 HA:750*2000	Platform:1050*850 HA:800*2000
1300	Platform:850*900 HA:600*2000	Platform:900*900 HA:650*2000	Platform:950*900 HA:700*2000	Platform:1000*900 HA:750*2000	Platform:1050*900 HA:800*2000
1350	Platform:850*950 HA:600*2000	Platform:900*950 HA:650*2000	Platform:950*950 HA:700*2000	Platform:1000*950 HA:750*2000	Platform:1050*950 HA:800*2000
1400	Platform:850*1000 HA:600*2000	Platform:900*1000 HA:650*2000	Platform:950*1000 HA:700*2000	Platform:1000*1000 HA:750*2000	Platform:1050*1000 HA:800*2000

instruction  
 Outer width of shaft: The outer width of the shaft frame;  
 Outer depth of the shaft: the outer depth of the shaft frame;  
 The customer needs to prepare installation space:  
 outer shaft width+30mm, outer shaft depth+20mm  
 Platform: 850\*600 means platform width is 850mm and platform depth is 600mm  
 Platform size W= outer shaft width-50mm, D= Well outer depth-400mm;  
 HA:600\*2000 means door opening mode is swing door or manual door,  
 door width 600mm, door height 2000mm;  
 Swing door: OP= outer shaft width-300mm  
 Hand door: OP= outer shaft width-255mm  
 The aluminum shafts shall be fixed on the steel structure or the structure of concrete with ring beam.  
 The structure shall be at back side of shaft.  
 Rated load ≤ 320kg, opening doors mode: chosen by specific projects and customer needs

## Table of Car Size vs Rate Load

CW \ CD	650	700	750	800	850	900	950	1000	1050	1100	1150	1200	1250
650	260kg	260kg	260kg	260kg	260kg	260kg	260kg	320kg	320kg	320kg	320kg	320kg	320kg
700	260kg	260kg	260kg	260kg	260kg	260kg	320kg	320kg	320kg	320kg	320kg	320kg	320kg
750	260kg	260kg	260kg	260kg	260kg	320kg	320kg	320kg	320kg	320kg	320kg	320kg	320kg
800	260kg	260kg	260kg	260kg	320kg	320kg	320kg	320kg	320kg	320kg	320kg	320kg	320kg
850	260kg	260kg	260kg	320kg	320kg	320kg	320kg	320kg	320kg	320kg	320kg	320kg	320kg
900	260kg	260kg	320kg	320kg	320kg	320kg	320kg	320kg	320kg	320kg	320kg	320kg	400kg
950	260kg	320kg	320kg	320kg	320kg	320kg	320kg	320kg	320kg	320kg	320kg	400kg	400kg
1000	320kg	320kg	320kg	320kg	320kg	320kg	320kg	320kg	320kg	320kg	400kg	400kg	400kg
1050	320kg	320kg	320kg	320kg	320kg	320kg	320kg	320kg	320kg	400kg	400kg	400kg	400kg
1100	320kg	320kg	320kg	320kg	320kg	320kg	320kg	320kg	400kg	400kg	400kg	400kg	400kg
1150	320kg	320kg	320kg	320kg	320kg	320kg	400kg	400kg	400kg	400kg	400kg	400kg	400kg
1200	320kg	320kg	320kg	320kg	320kg	320kg	400kg	400kg	400kg	400kg	400kg	400kg	400kg
1250	320kg	320kg	320kg	320kg	320kg	400kg	400kg	400kg	400kg	400kg	400kg	400kg	400kg

Note: CW stands for Car Width, CD stands for Car Depth. 260kg standard car size is 850\*850, 320kg standard car size is 900\*1200, 400kg standard car size is 1000\*1250

## Project Reference

