



ESCALATOR & PASSENGER CONVEYOR

We reserve the right to alter some of specifications and descriptions given here in without prior notices



E-mail: info@rital.com.tr
whatsapp: +905303317401 +90 536 814 04 60
Address: Kayabaşı Mh. Akzambak Sk. adim



KUKA Robot



SAVANINI Products Line



Workshop

MANUFACTURE FACILITY

Believed that best quality comes from the best equipment, **Rital** has imported the world's first class facilities.

At present, **Rital** has 6 sheet metal lines, SMT automatic electronic product line, SALVAGNINI flexible product lines, KUKA robots, welding robots, escalator assembly product lines, etc. All these can well guarantee our manufacturing quality.

GOOD APPEARANCE

As a part of the building, appearance of escalator should be harmonious with architecture style.

A variety of appearance solution could be designed. Outer cladding of escalator could be provided by **Rital** or by local to be suitable to architecture.



Color plate



LED spot lighting



Hairline Stainless Steel LED spot lighting



Ti-Aluminum plate LED spot lighting



Mirror Stainless Steel LED spot lighting



Glass outer cladding



Elevana

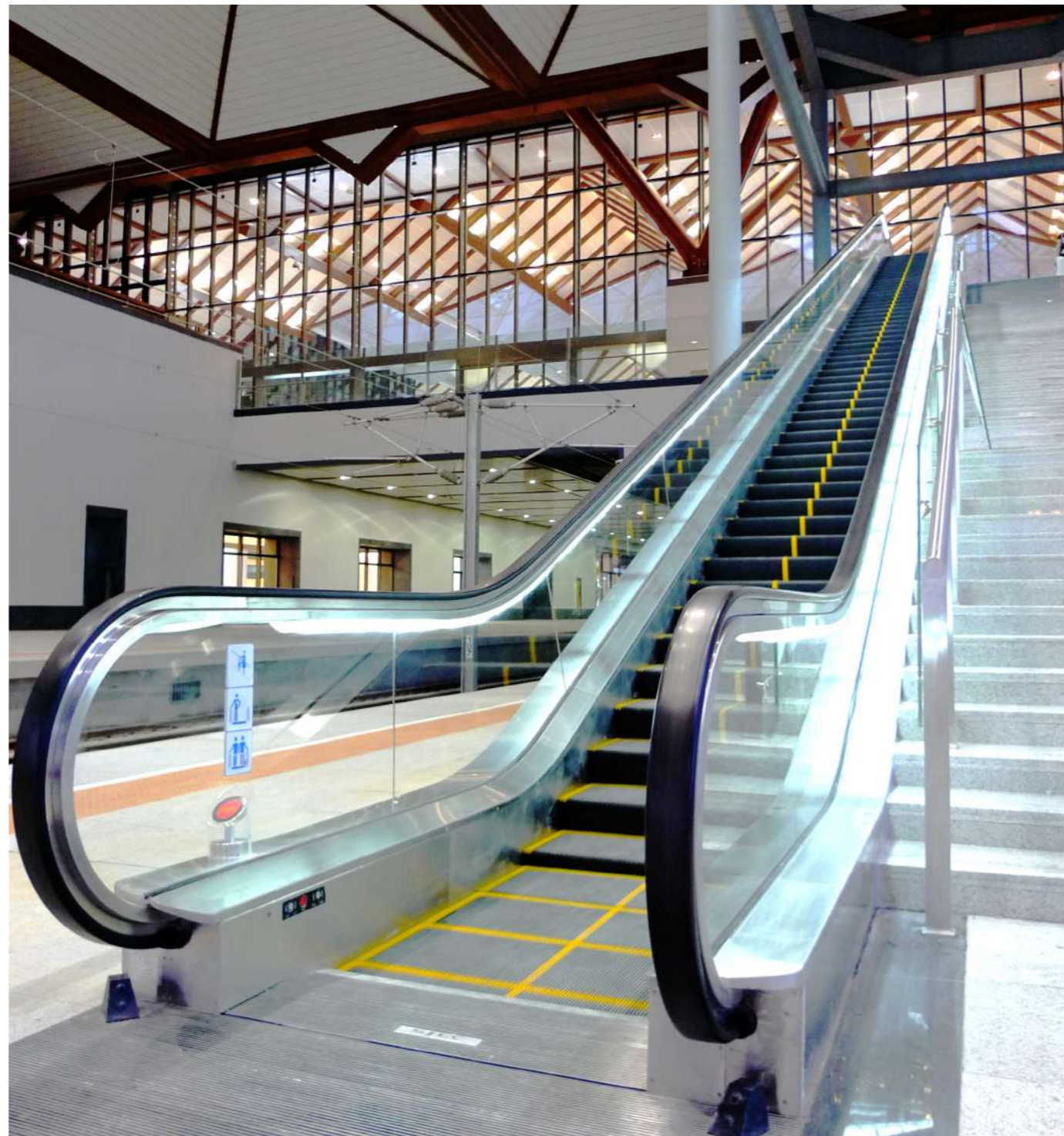

Elevana

HANDRAIL (Different color as option)



Black Dark grey Blue Green Pink Red White

Various optional specifications are available, such as appearance options according to different architecture style, and the functions according to clients' requirements.

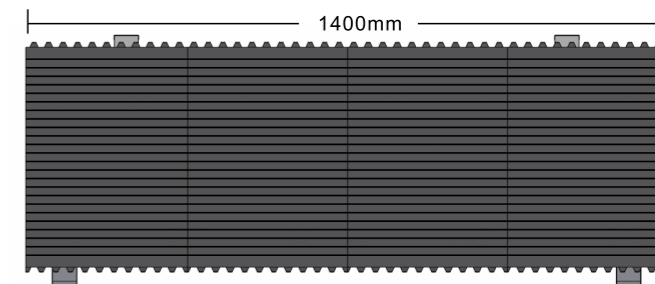
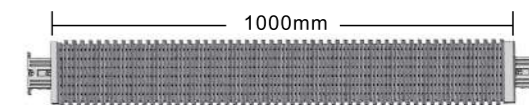
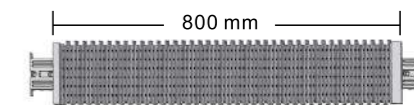

PALLETS

Die-cast aluminum 800~1400mm

STEP

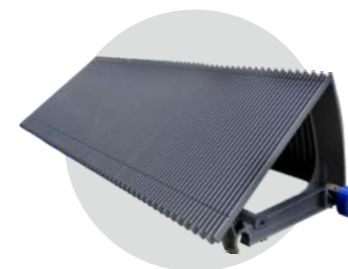

Aluminum alloy Die-cast (gray color as default)

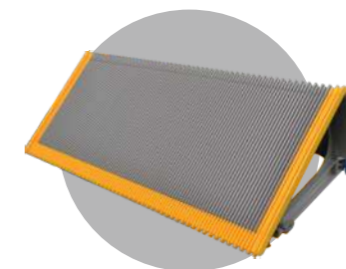

Aluminum alloy Die-cast With yellow synthetic resin (gray color as default)

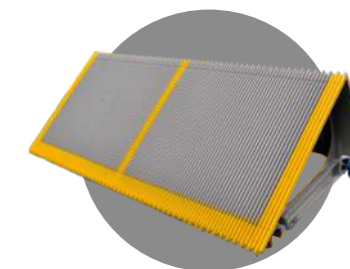

Aluminum alloy Die-cast With yellow painted line (gray color as default)

OPTIONAL FEATURES



Handrail Entrance



Combs Llighting



Anit-climb Device

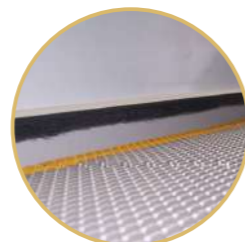

Skirting Brush



Skirting Lighting

FES Escalator

Silence and comfort. The new generation has inherited the traditional safety, reliability, high efficiency style and combined with updated market trends as well as tailored solutions. It is widely used for shopping malls, Hotels, office blocks and etc.



Type	FES
Inclination	30° /35°
Step width(mm)	600/800/1000
Horizontal step run (mm)	800/1200
Speed (m/s)	0.5
Power supply	AC 3 phase.5 wire50Hz/60Hz
Installation position	Indoor/ Outdoor
Rise(m)	2~6/8.3 (Details as following)

Rise (m)	Inclination	Horizontal step Qty
2~6	30°/35°	2
2~8.3	30°	3

Type	Standard	Optional
Balustrade design	Vertical safety glass (10mm safety tempered glass)	
Balustrade profile	Q235/SS	
Handrail	Black	Other colors
Deckings	Hairline SS	
Skirting panel	Hairline SS	
Step	Aluminum alloy Die-cast, gray color	
Landing plate	Punched SS	Etched SS/Extrude aluminum
Operation panel	Red emergency stop button and up/down key switch	



FEH/FEH20 Escalator

Weatherproof and unique balustrade design, conform to special customer specifications. It is suit for airport, subway and overpass etc.

Specs	Escalator	
	FEH	FEH20
Type	FEH	FEH20
Inclination	23.2°/27.3°/30°/35°	30°
Step width(mm)	600/800/1000	
Horizontal step run(mm)	800/1000/1200	1200/1600
Upper radius	1500/2700	2700/4000
Speed(m/s)	0.5/0.65	
Power supply	AC 3 phase 5 wire 50Hz/60Hz	
Installation position	Indoor/Outdoor	
Rise(m)	2-15	3-50
Roller diameter(mm)	φ80	φ100
Roller position	Inside the chain link	Outside the chain link



Type	Standard	Optional
Balustrade design	Vertical safety glass(10mm safety tempered glass)	Inclined SS
Balustrade profile	Hairline SS	
Handrail	Black	Other colors
Deckings	Hairline SS	
Skirting panel	Hairline SS	
Step	Aluminum alloy Die-cast, gray color	
Landing plate	Etched Stainless steel	Extrude aluminum with surface of stainless steel/Extrude aluminum
Operation panel	Red emergency stop button and up-down key switch	



Passenger Conveyor

Is reliable, high efficiency, easy for maintenance , which is suit for hypermarket and airport .

Specs	Passenger conveyor		
	FET	FEF	FEW
Type	FET	FEF	FEW
Inclination	10° 11° 12°	10° 11° 12°	0° – 6°
Pallet width (mm)	800/1000	800/1000	1000/1200/1400
Horizontal pallet run (mm)	400(upper landing)	400	N/A
Speed (m/s)	0.5		
Power supply	AC 3 phase.5 wire50Hz/60Hz		
Installation position	Indoor/Outdoor		
Rise/Length(m)	H: 2~8.3	H: 2~8.3	L: 20~120



Type	Standard	Optional
Balustrade design	Vertical safety galss(10mm safety tempered glass)	Inclined SS for FEW
Balustrade profile	Hairline SS	
Handrail	Black	Other colors
Deckings	Hairline SS	
Skirting panel	Hairline SS	
Pallet	Die-cast aluminum	
Landing plate	Punched SS	Etched SS/Extrude aluminum
Operation panel	Red emergency stop button and up-down key switch	

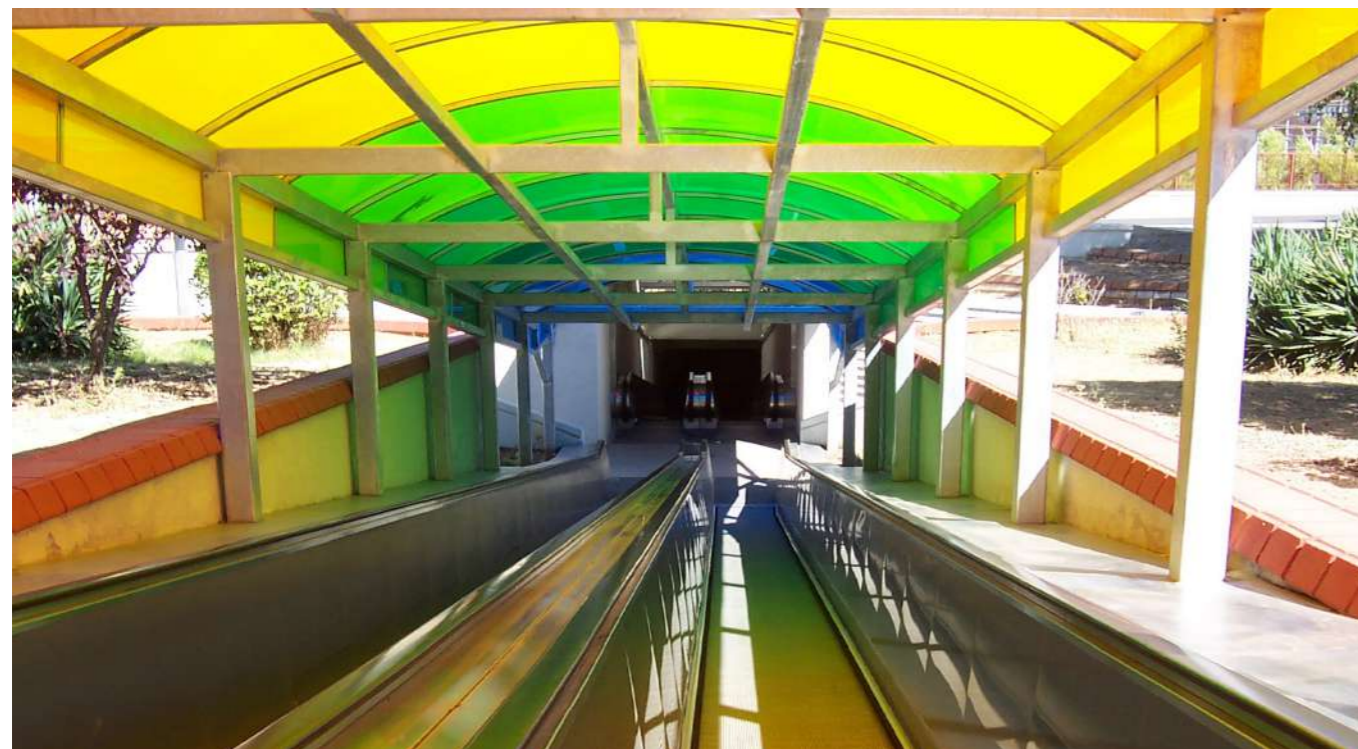

FEB Trolley Conveyor

A shopping carts/trolleys transportation system with high efficiency, small installation space, low energy consumption. Usually installed besides escalators, separate person / trolley into 2 ways for better safety and convenience.

Type	FEB	
Inclination	30°	35°
Speed (m/s)	0.5	
Power supply	AC 3 phase, 5 wire, 50Hz/60Hz	
Installation position	Indoor	
Rise	2~7.5 m	2~6m

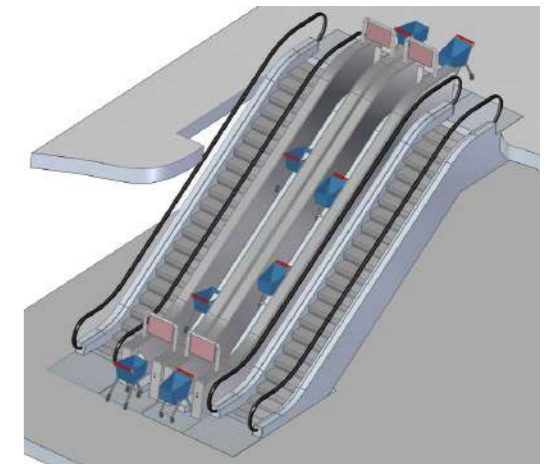
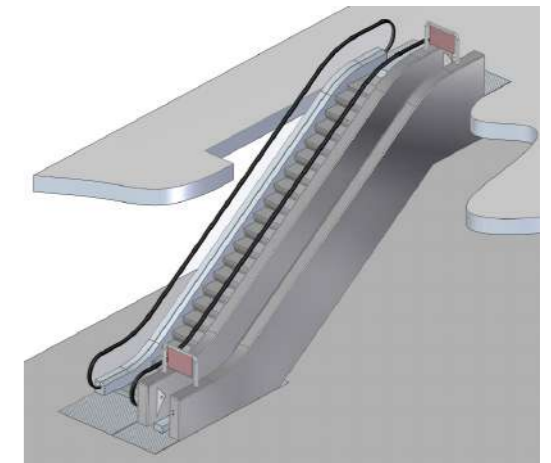

Spec	Standard	Optional
Cladding	Q235	SS
Guide rail	Hairline SS	
Landing plate	Anti-skidding SS	
Operation panel	Red emergency stop button, start key switch	

NOTE:
The cart shall be suitable to the conveyor. It is recommended to be ordered from us.
Trolley conveyor is not compliant with and in scope range of EN115.



FUNCTIONS	FES	FEH	FEH20	FET/FEF	FEW
Stop button	●	●	●	●	●
Key switch	●	●	●	●	●
Handrail entrance contact	●	●	●	●	●
Pallet/Step-chain broken contact	●	●	●	●	●
Pallet/Step sag contact	●	●	●	●	●
Phase monitor	●	●	●	●	●
Zinc steel flying wheel cover	●	●	●	●	●
Pallet/Step reversing fences	●	●	●	●	●
Motor overload	●	●	●	●	●
Motor overheat	●	●	●	●	●
Comb contact	●	●	●	●	●
Maintenance interlock	●	●	●	●	●
Alarm buzzer	●	●	●	●	●
Overspeed & unintended reversal monitor	●	●	●	●	●
Handrail anti-static roller	●	●	●	●	●
Pallet/Step anti-static brush	●	●	●	●	●
Service brake release contact	●	●	●	●	●
Soft stop	●	●	●	●	●
Handrail speed monitor	●	●	●	●	●
Switchboard/power box	●	●	●	●	●
Landing plate switch	●	●	●	●	●
Alarm for stop distance overrun	●	●	●	●	●
Pallet/Step missing contact	●	●	●	●	●
Auto lubrication system (with oil collector)	●	●	●	●	●
LCD fault display (on the outer decking)	●	●	●	●	●
Earth leakage circuit-breaker for illumination circuit	●	●	●	●	●
Fire interface (110V)	●	●	●	●	●
Step upthrust contact	●	●	●	X	X
Safety brake on main shaft	○	●	●	○	○
Additional emergency stop device	○	○	○	●	○
Skirting contact	○	○	○	X	○
Pallet/Step gap illumination	○	○	○	○	○
Broken drive-chain contact	○	○	○	○	○
4 dry contacts for remote monitoring	○	○	○	○	○
Skirting lighting	○	○	○	○	○
LED comb lighting	○	○	○	○	○
Balustrade lighting	○	○	○	○	○
LED traffic light	○	○	●	○	○
Machine room lighting	○	○	○	○	○
Cable connector for divided pieces	○	○	○	○	○
Special requirement for cable	○	○	○	○	○
Handrail broken contact	○	○	○	○	○
Machine room stair	○	○	○	○	○
Outside cladding	○	○	○	○	○
Fire interface (24V)	○	○	○	○	○
Skirting brush	○	○	○	○	○
Anti-climb device	○	○	○	○	○
Semi-outdoor installation package	○	○	○	○	○
Outdoor installation package	○	○	○	○	○
Comb heater	○	○	○	○	○
Truss and comb heater	○	○	○	○	○

● Standard ○ Optional X Not available

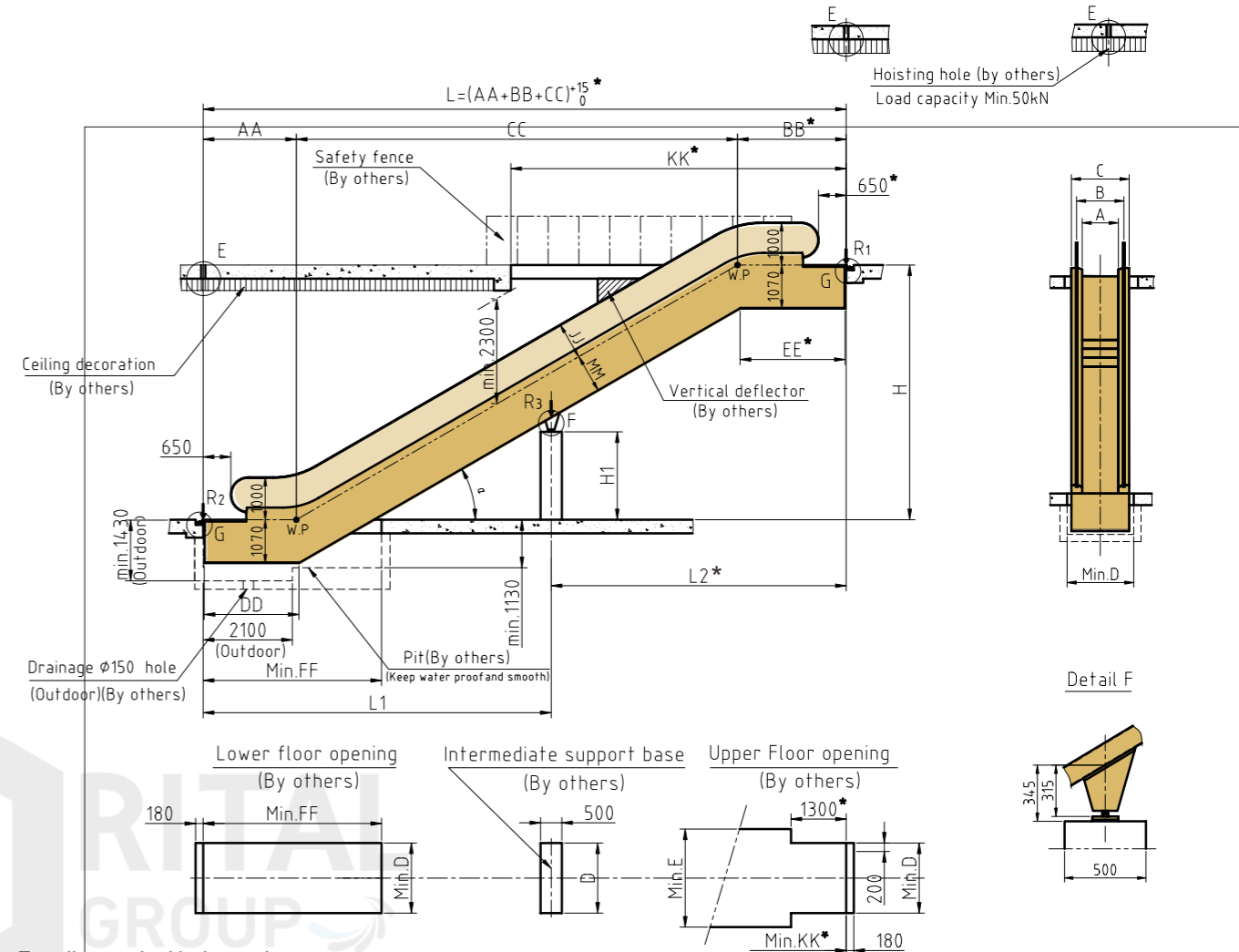

For slim-vertical balustrade

A	600	800	1000
B	837	1037	1237
C	1145	1345	1545
D	1200	1400	1600
E	1720	1920	2120

Type	a	AA	BB	CC	DD	EE	FF	JJ	KK	MM
FES-302	30°	2195	2449	H X 1.732	2238	2357	4200	870	7800	960
FES-352	35°	2229	2510	H X 1.428	2386	2304	4000	850	7000	980
FES-303	30°	2595	2964	H X 1.732	2638	2871	4600	870	8300	960

A	Reaction Force (KN)	
	W/o intermediate support	With one intermediate support
600	R1=3.35×L+15.5	R1=3.35×L2+11.5
	R2=3.35×L+10	R2=3.35×L1+4.5
		R3=3.35×L+3.5
800	R1=3.7×L+17	R1=3.7×L2+12
	R2=3.7×L+11	R2=3.7×L1+4.7
		R3=3.7×L+4
1000	R1=4.15×L+18.5	R1=4.15×L2+12.5
	R2=4.15×L+11.5	R2=4.15×L1+4.9
		R3=4.15×L+4.5

Note: 1.L, L1, L2 is in meter

NOTE:

- Height above sea level
Height above sea level of the placed escalators shall be no greater than 1000m.in case of particular,please contact Rital.
- If one of the following situations is met, the dimensions with mark * shall be extended 500mm
(1) 600 mm step.
(2) double drive .
(3) Main power 200Vgrade and motor power more than 7.5KW.
- Client shall provide the intermediate support base which can be made by the reinforced concrete or metallic structure in right position in case of horizontal distance L over 15 m.
- The requirements for the interface between the escalator and the building shall meet the national standard(EN115-1:2017).
If doubt, please contact Rital

We reserve the right to alter some of specifications and descriptions given here in without prior notices.



FEH Layout for Public Service Escalator

Elevana

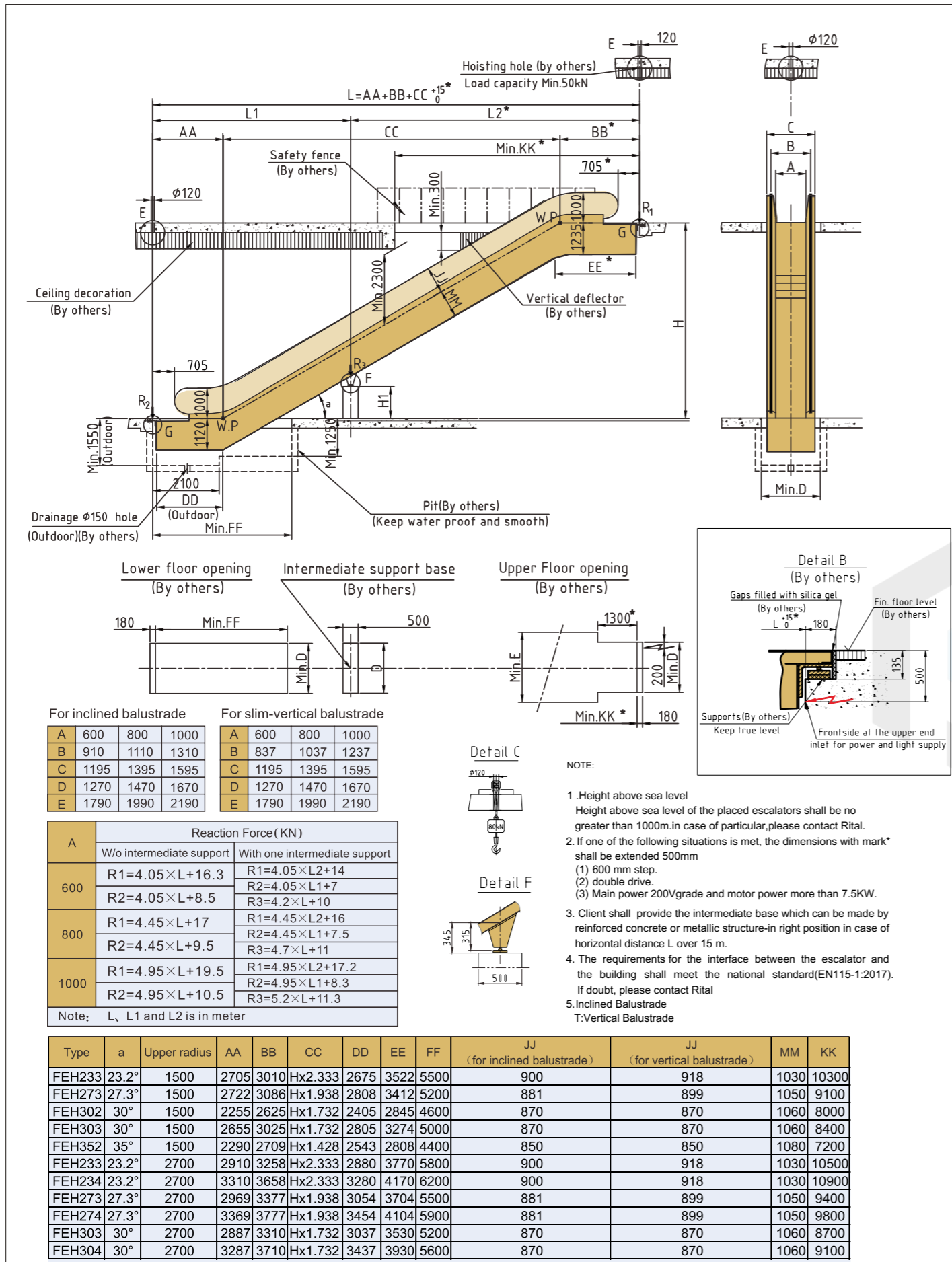

We reserve the right to alter some of specifications and descriptions given here in without prior notices.

FEH20 Layout for Public Service Escalator



Elevana

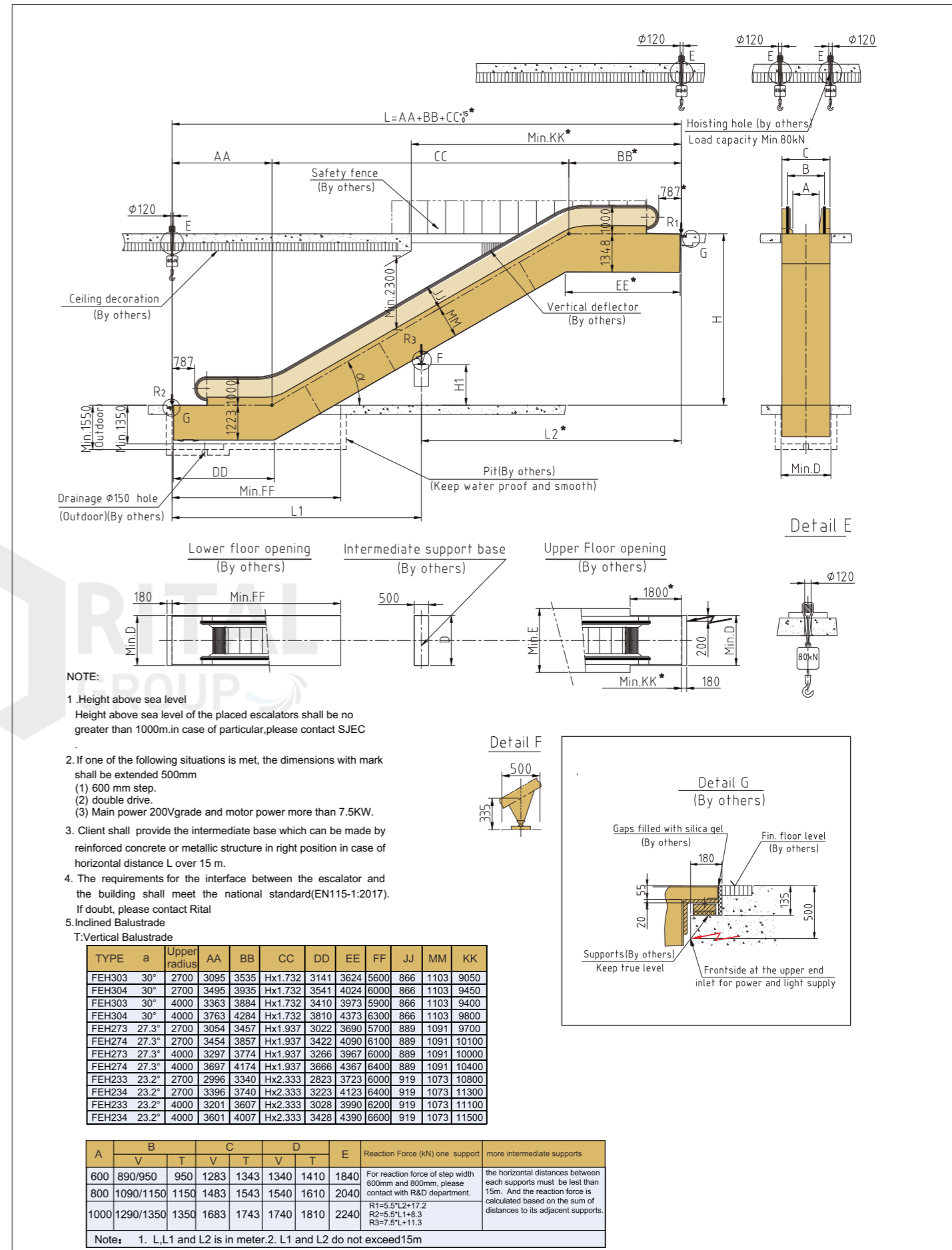

We reserve the right to alter some of specifications and descriptions given here in without prior notices.



FEF Layout for Passenger Conveyor

Elevana

FET Layout for Passenger Conveyor



Elevana

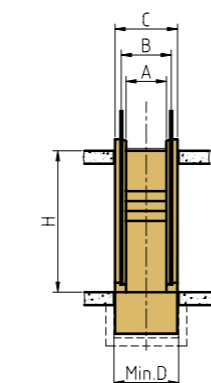
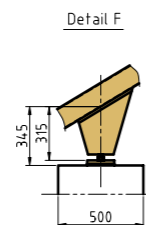
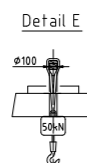
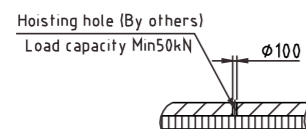
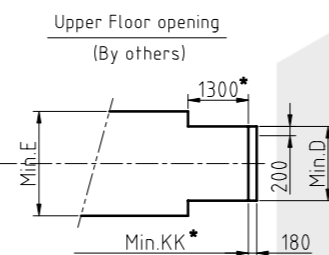
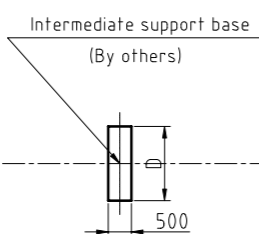
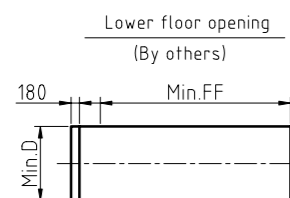
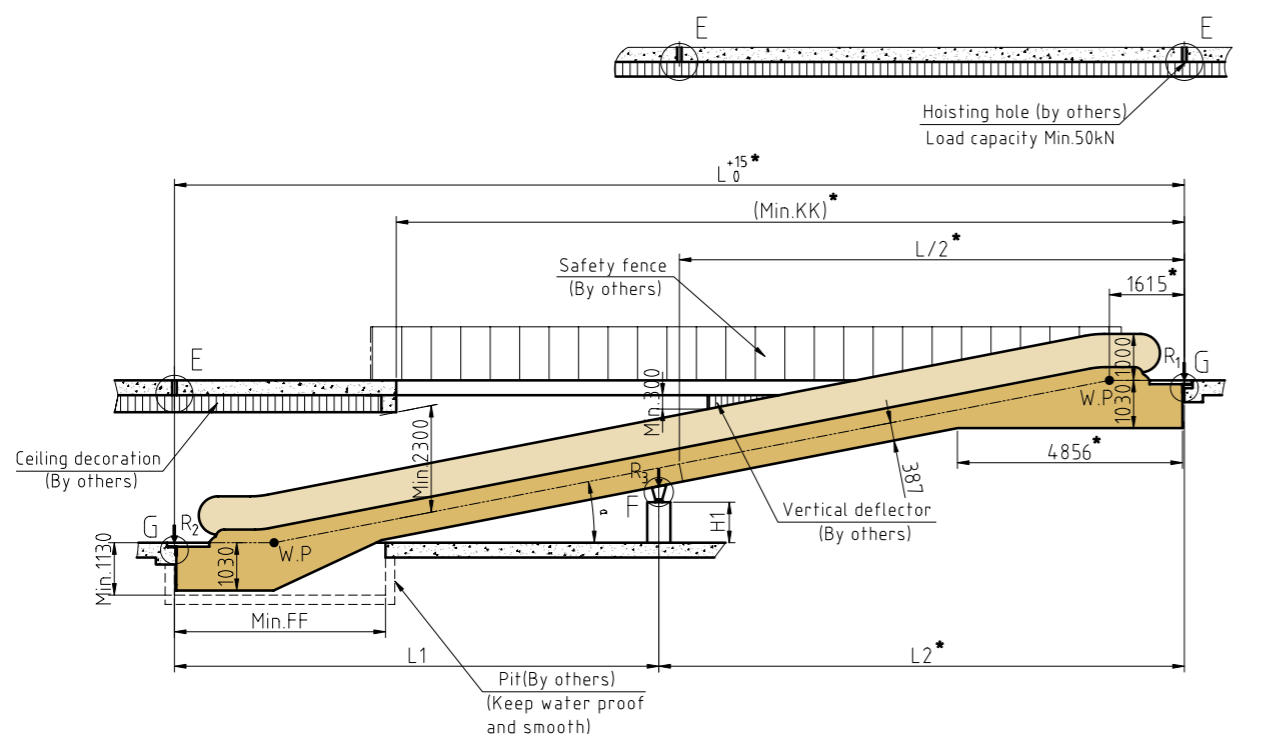

A	800	1000
B	1037	1237
C	1345	1545
D	1400	1600
E	1920	2120

Type	A	L	KK	FF
FEF10	10°	H×5.671+3945	17700	4750
FEF11	11°	H×5.145+3755	16700	4550
FEF12	12°	H×4.705+3595	15800	4500

NOTE:

- Height above sea level
Height above sea level of the placed moving walks shall be no greater than 1000m.in case of particular, please contact Ritral.
- If one of the following situations is met, the dimensions with mark* shall be extended 500mm
(1) double drive.
(2) Main power 200V grade and motor power more than 7.5KW.
- Client shall provide the intermediate support base which can be made by the reinforced concrete or metallic structure in right position in case of horizontal distance L over 10 m.
- The requirements for the interface between the escalator and the building shall meet the national standard(EN115-1:2017). If doubt, please contact Ritral

A	Reaction Force (KN)
800	R1=3.45×L2+12.5
	R2=3.45×L1+4
	R3=4×L+14.5
1000	R1=3.85×L2+14
	R2=3.85×L1+4.5
	R3=4.5×L+15.5

Note: 1.L, L1 and L2 is in meter
2.L1 and L2 do not exceed 10m
3.Applicable in case of one intermediate support ,or else, contact us

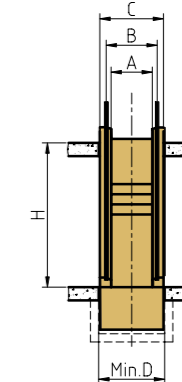
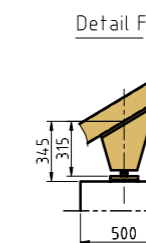
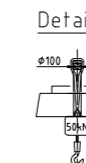
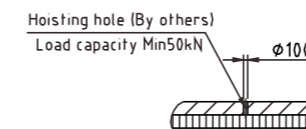
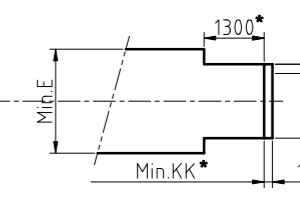
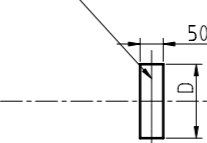
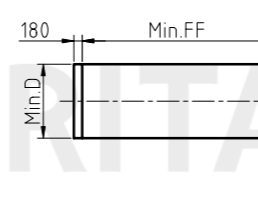
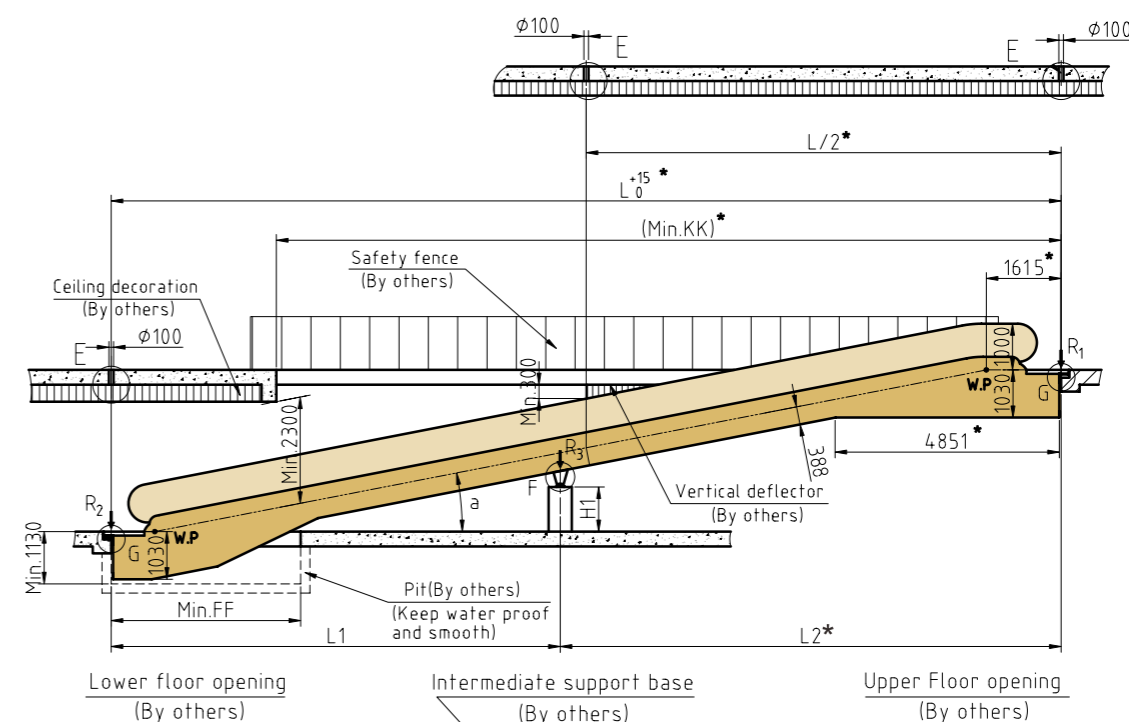
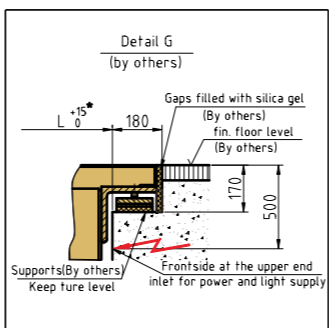

A	800	1000
B	1037	1237
C	1345	1545
D	1400	1600
E	1920	2120

Type	A	L	KK	FF
FET10	10°	H×5.671+2650	17700	4250
FET11	11°	H×5.145+2555	16700	4150
FET12	12°	H×4.705+2475	15800	4000

NOTE:

- Height above sea level
Height above sea level of the placed moving walks shall be no greater than 1000m.in case of particular, please contact Ritral.
- If one of the following situations is met, the dimensions with mark* shall be extended 500mm
(1) double drive.
(2) Main power 200V grade and motor power more than 7.5KW.
- Client shall provide the intermediate support base which can be made by the reinforced concrete or metallic structure in right position in case of horizontal distance L over 10 m.
- The requirements for the interface between the escalator and the building shall meet the national standard(EN115-1:2017). If doubt, please contact Ritral

A	Reaction Force (KN)
800	R1=3.45×L2+12.5
	R2=3.45×L1+4
	R3=4×L+14.5
1000	R1=3.85×L2+14
	R2=3.85×L1+4.5
	R3=4.5×L+15.5

Note: 1.L, L1 and L2 is in meter
2.L1 and L2 do not exceed 10m
3.Applicable in case of one intermediate support ,or else, contact us

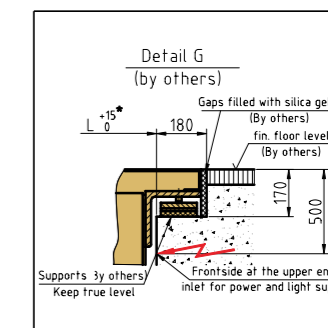



Project Highlight

Elevana



Sevilla metro, Spain



Suzhou railway station, China



Cologne, Germany



Saturn Mall, Greece



House of Fraser Shopping Mall, England



Project Highlight



Elevana



KCIC Halim Station, Indonesia



Rio de Janeiro Airport, Brazil



Chennai train station, India



Metrosol-Parasol, Spain



ARTIC, USA



ORIENTAL ARC, China



Hamburg Mobelhaus Shopping Center, Germany



BMW North Shore, New Zealand